

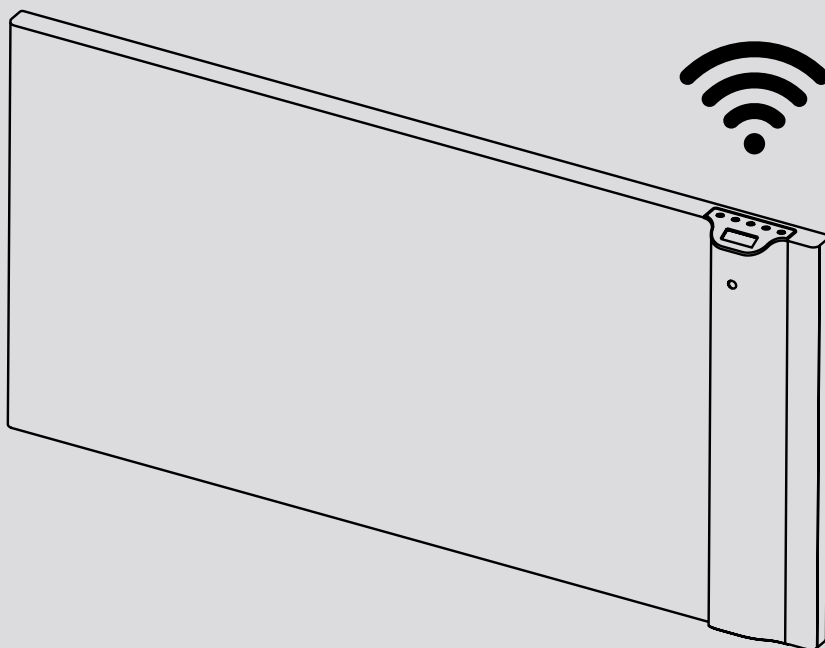

KLIMA Wi-Fi

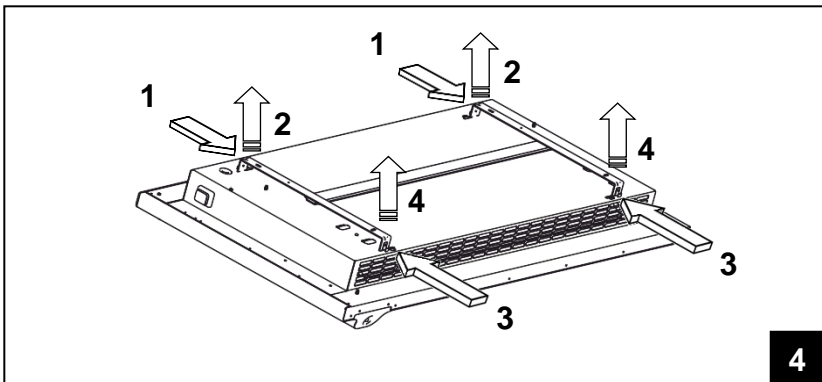

- IT Leggere il manuale d'uso. Conservare con cura le istruzioni per ogni futura consultazione.
- EN Please retain these instructions in a safe place for further reference.
- SL Prosimo shranite ta navodila na varnem mestu za kasnejšo rabo..
- RO Pastrati instructiunile pentru consultari ulterioare.
- NL Bewaar deze instructies op een veilige plaats voor toekomstig gebruik.
- PL Zachowaj instrukcję w bezpiecznym miejscu, aby móc z niej skorzystać w przyszłości.

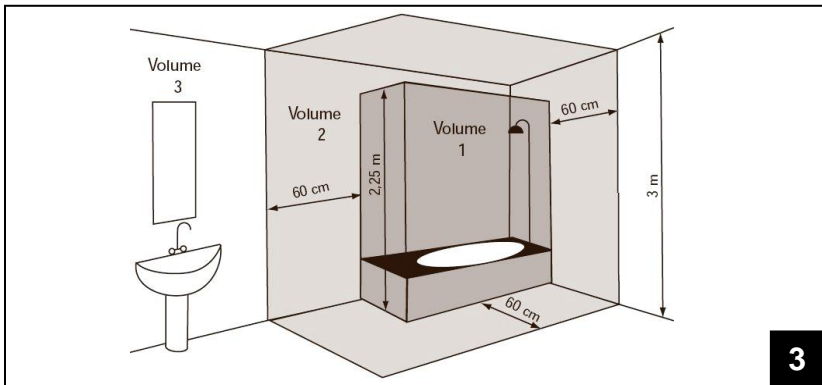
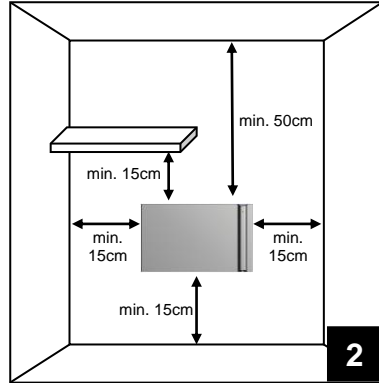
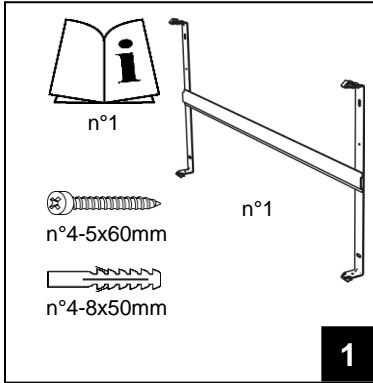

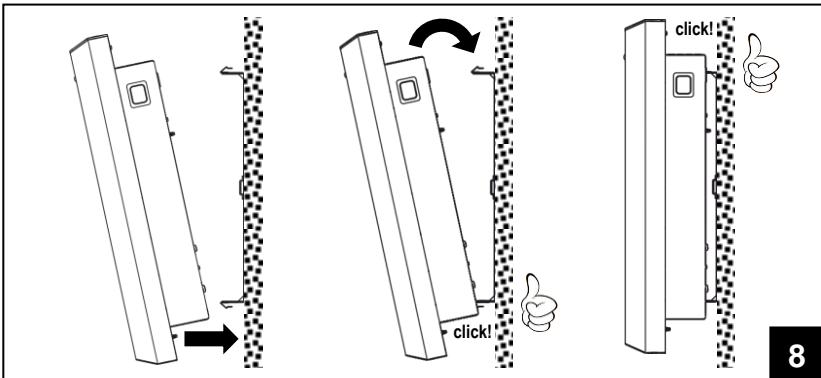
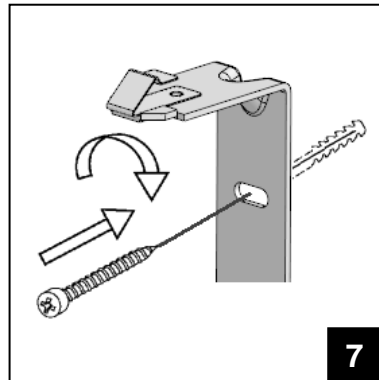
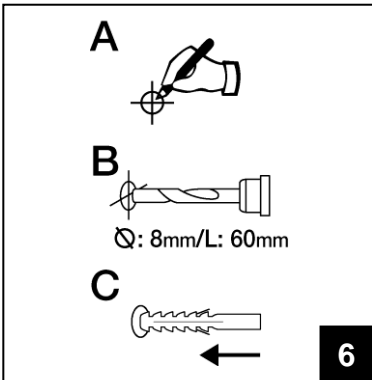
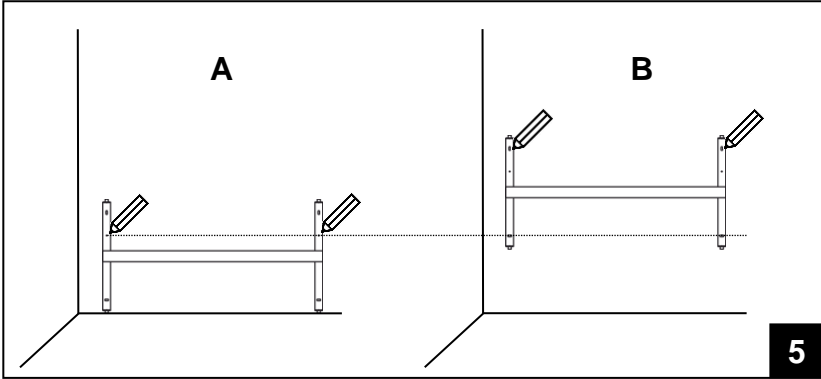

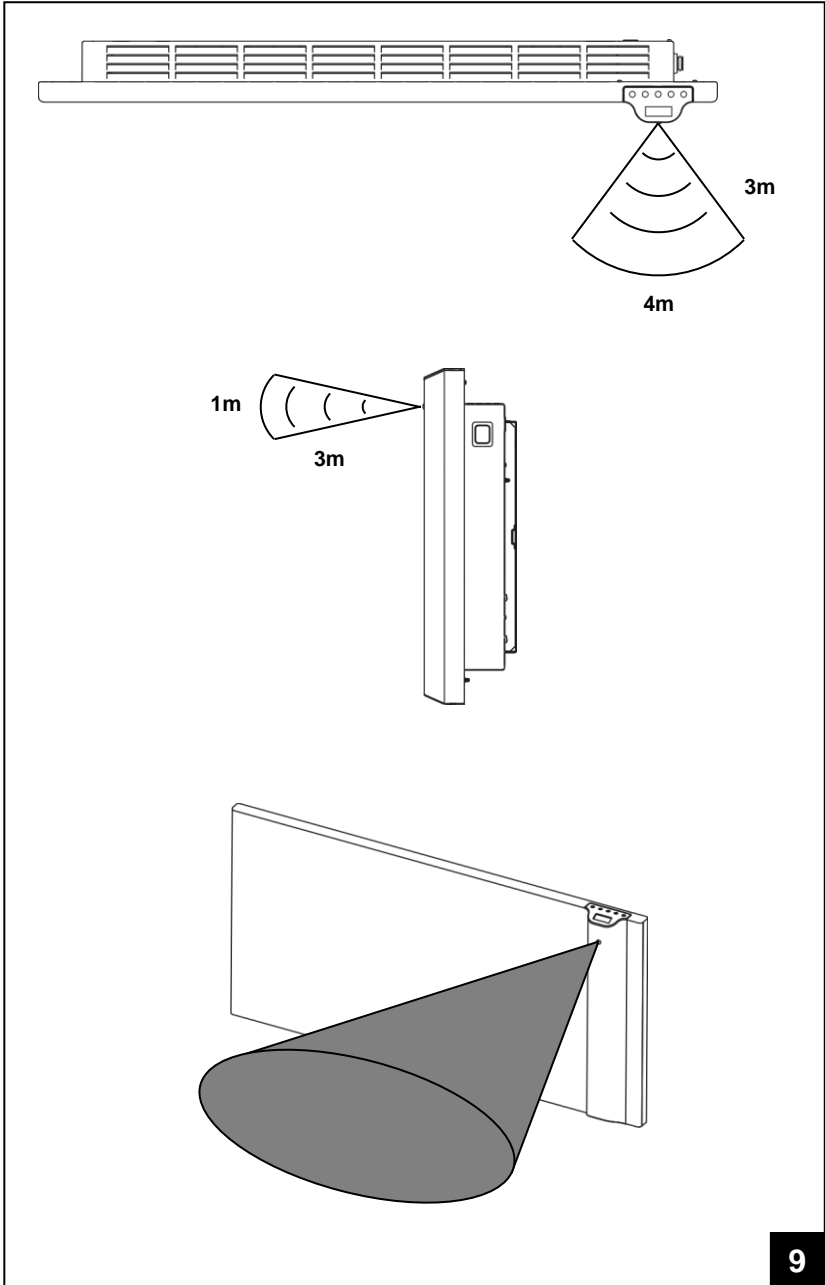

ISTRUZIONI PER L'USO

Si prega di leggere attentamente queste istruzioni, prima di utilizzare il prodotto, in modo da evitare danneggiamenti o comunque il verificarsi di situazioni di pericolo. Qualsiasi utilizzo del prodotto diverso da quanto indicato nel presente manuale può causare incendi, pericoli elettrici o ferite e rende nulla qualsiasi garanzia.

La garanzia non si applica ad alcun difetto, deterioramento, perdita, ferimento o danneggiamento riconducibili ad un uso non corretto del prodotto. Rimangono garantiti tutti i diritti di legge in materia. Nessuna condizione di garanzia può escludere o modificare le condizioni di garanzia regolamentate da leggi dello Stato che non possono essere a nessun titolo escluse o modificate.

Prima di ogni operazione, rimuovere con cura l'imballo e controllare la perfetta integrità del prodotto. Nel caso si evidenziasse dei difetti o danni, non installare né cercare di riparare l'apparecchiatura, ma rivolgersi al rivenditore.

Non lasciare l'imballo alla portata dei bambini e smaltirne le parti in conformità con le disposizioni vigenti.

1. Per la Vostra sicurezza

- ❑ Questo prodotto è per uso domestico e non è adatto per l'utilizzo su veicoli, imbarcazioni o aeromobili.
- ❑ L'apparecchio può essere utilizzato da bambini di età non inferiore a 8 anni e da persone con ridotte capacità fisiche, sensoriali o mentali, o prive di esperienza o della necessaria conoscenza, purché sotto sorveglianza oppure dopo che le stesse abbiano ricevuto istruzioni relative all'uso sicuro dell'apparecchio e alla comprensione dei pericoli ad esso inerenti. I bambini non devono giocare con l'apparecchio. La pulizia e la manutenzione destinata ad essere effettuata dall'utilizzatore non deve essere effettuata da bambini senza sorveglianza.
- ❑ I bambini di età inferiore a 3 anni non devono avvicinarsi al prodotto se non costantemente supervisionati.
- ❑ I bambini di età compresa fra 3 e 8 anni possono solamente accendere e spegnere l'apparecchio purché esso sia stato installato e posizionato secondo le normali condizioni d'uso e loro siano supervisionati o adeguatamente istruiti riguardo al corretto e sicuro utilizzo del prodotto e ne abbiano compresa la pericolosità. I bambini di età compresa fra 3 e 8 anni non possono collegare il prodotto, regolarlo, pulirlo o effettuare manutenzione.
- ❑ **ATTENZIONE: Alcune parti di questo prodotto possono diventare molto calde e causare bruciature. Particolare attenzione deve essere prestata in presenza di bambini o persone vulnerabili.**
- ❑ Assicuratevi che l'alimentazione di rete corrisponda ai dati di targa: 230V AC, 50Hz.

- ❑ Non lasciate mai che animali o bambini giochino o tocchino il prodotto. Attenzione! Durante il funzionamento il pannello può diventare molto caldo (circa 80°C = 176°F);
- ❑ **IMPORTANTE: per evitare surriscaldamenti non ricoprite mai il prodotto.** Non appoggiate mai alcun oggetto o coperta sull'apparecchio mentre è in funzione. Questo è chiaramente scritto sull'apparecchio o illustrato dal simbolo



- ❑ Non utilizzate il prodotto in stanze sature di gas esplosivi, di vapori generati da solventi e vernici o comunque di vapori/gas infiammabili.
- ❑ Se il cavo e/o la spina sono danneggiati e devono essere riparati, non eseguite questa operazione da soli, riportate il prodotto presso il centro di assistenza tecnica, o comunque in un centro di riparazioni qualificato, perché è richiesto l'intervento di personale specializzato al fine di evitare qualunque rischio di danneggiamento.
- ❑ Il prodotto deve essere posizionato in modo tale che la presa di alimentazione sia sempre raggiungibile.
- ❑ Non collocate mai questo apparecchio immediatamente al di sotto di una presa di corrente elettrica.
- ❑ Non inserite nessun oggetto o carta all'interno del radiatore.

2. Il vostro prodotto

- ❑ Il prodotto viene fornito dotato di (figura 1):
 - N°1 staffa metalliche per l'installazione a muro (fissata al radiatore);
 - N°4 tasselli in nylon da 8x50mm;
 - N°4 viti per tasselli da 5x60mm;
- ❑ Qualora il prodotto sia danneggiato o qualche accessorio mancante contattate immediatamente il vostro rivenditore.

3. Posizionamento sicuro

- ❑ Utilizzate il prodotto solo in posizione orizzontale;
- ❑ Il prodotto è costruito in doppio isolamento elettrico (classe II) e, pertanto, non richiede il collegamento di terra;
- ❑ Fate sempre attenzione affinché siano rispettate le distanze minime da pareti, mobili e/o oggetti riportati in figura 2.
- ❑ Non installate mai il prodotto su superfici di legno o di materiale sintetico.
- ❑ Il prodotto ha un grado IP24 di protezione all'acqua. Può pertanto essere utilizzato nei bagni o nei luoghi umidi ma mai installato all'interno del perimetro di vasche o docce (Volume 1 di figura 3).
- ❑ Non installate il prodotto dove vi sono spifferi o correnti d'aria.

4. Installazione

- ❑ Rimuovete la staffa per l'installazione a muro fissata sul posteriore del radiatore facendo scattare prima le 2 molle superiori e successivamente le 2 molle inferiori come illustrato in figura 4.
- ❑ Appoggiate la staffa sul pavimento per utilizzarla come dima per marcare con una matita i punti in cui effettuare i 2 fori di fissaggio inferiori (figura 5A).
- ❑ Sollevate la staffa fino a far coincidere i suoi punti di fissaggio inferiori con le marcature sul muro precedentemente realizzate e marcate con una matita la posizione dei due punti di fissaggio superiore (figura 5B).
- ❑ Realizzate i fori nei 4 punti precedentemente marcati ed inserite i tasselli in plastica (figura 6).
- ❑ Fissate la staffa a muro usando le 4 viti in dotazione (figura 7).
- ❑ Agganciate il prodotto alla staffa iniziando dai 2 punti di fissaggio inferiori e poi facendo scattare in posizione i 2 punti di fissaggio superiori (figura 8).

- Qualora sia necessario rimuovere il prodotto dalla staffa, si raccomanda di sganciare per primi i due punti di fissaggio inferiori e successivamente quelli superiori.

5. Collegamenti elettrici

- Il prodotto deve essere alimentato con la tensione di 230V AC 50Hz.
- Il prodotto può essere fornito dotato di cavo con spina oppure di cavo per l'installazione. Nel caso un prodotto con spina debba essere installato in Francia, il collegamento elettrico con la rete di alimentazione deve essere eseguito tagliando la spina in dotazione e utilizzando una apposita scatola di connessione.
- Quando il prodotto viene fornito con il cavo per l'installazione senza spina, il collegamento deve essere effettuato usando un cavo a 3 fili (Marrone=Fase, Blu=Neutro, Nero=Filò pilota) e una scatola di connessione. **Se non si desidera utilizzare le funzionalità del filo pilota limitarsi al collegamento della fase e del neutro: il prodotto funzionerà correttamente anche senza la presenza del programmatore esterno.**
- In locali umidi, nei bagni o nelle cucine, il morsetto di collegamento deve essere installato ad almeno 25cm dal pavimento.
- Il collegamento elettrico con la rete deve inoltre prevedere l'utilizzo di un interruttore bipolare con una distanza minima di apertura fra i contatti di almeno 3mm. Rispettate sempre in modo prioritario le regole di installazione vigenti nel vostro paese.
- La connessione di terra è vietata. **NON COLLEGATE A TERRA IL FILO PILOTA (NERO).**
- Se il prodotto deve essere alimentato attraverso un interruttore differenziale da 30mA di sicurezza, accertarsi che anche il filo pilota sia sotto il controllo dell'interruttore differenziale.

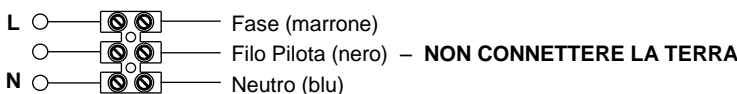

6. Uso del prodotto

6.1 Descrizione dei comandi

- A – Accensione/Stand-by
- B – Modo di funzionamento
- C – Funzioni speciali
- D – Incremento / Attivazione
- E – Decremento / Disattivazione
- F – Display
- G – Interruttore generale

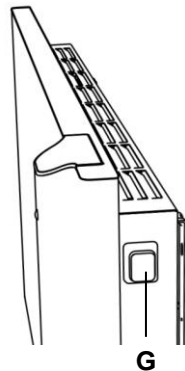
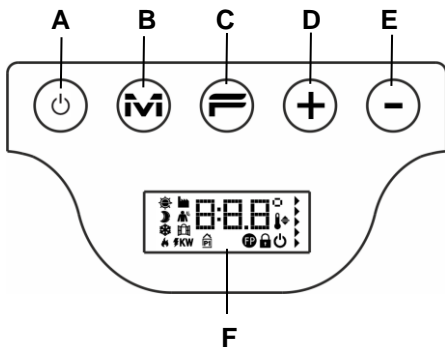

6.2 Funzionamento

6.2.1 Illuminazione dello schermo

Se lo schermo non è acceso premete un qualsiasi tasto per attivarne l'illuminazione.
 Lo schermo si illumina e rimane acceso per 30 secondi dall'ultima pressione di un qualsiasi tasto.

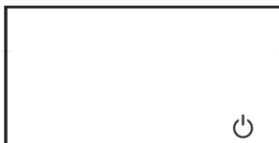





Quando lo schermo è spento, la prima pressione di un qualsiasi tasto accende l'illuminazione senza attivare la funzione corrispondente al tasto premuto.



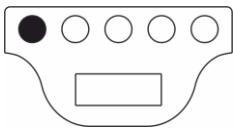

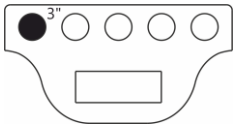

6.2.2 Accendere e spegnere il radiatore

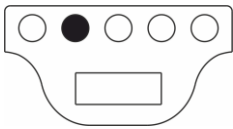

L'alimentazione generale del prodotto è controllata tramite un interruttore elettromeccanico bipolare (G) posto sul lato destro del radiatore. Utilizzando questo interruttore si interrompe l'alimentazione anche alla scheda elettronica con la conseguente perdita, dopo circa 30 minuti, di tutti i parametri memorizzati e il ripristino delle impostazioni di fabbrica.

Raccomandiamo di utilizzare questo interruttore solo se il prodotto non verrà utilizzato per lunghi periodi e di usare invece il pulsante di Accensione/Stand-by (A) per gli spegnimenti di breve periodo in modo da non perdere le impostazioni memorizzate.



<p>All'accensione del prodotto con l'interruttore generale posto sul lato, il display si illumina e si accende il simbolo di stand-by.</p>		
<p>Per accendere il prodotto, premere il tasto Accensione/Stand-by.</p> 		<p>Il prodotto si accende sempre in modalità comfort. Se il radiatore è nuovo o l'alimentazione di rete è mancata per più di 30 minuti la temperatura di comfort è quella di default pari a 19°C.</p>
<p>Per spegnere il prodotto, premere il tasto Accensione/Stand-by per almeno 3 secondi.</p> 		<p>Lo spegnimento del prodotto con l'interruttore basculante posto sul lato per oltre 30 minuti causa la perdita di tutti i dati memorizzati (data, ora, temperatura desiderata ecc.).</p>

6.2.3 Selezionare il modo di funzionamento

<p>La pressione progressiva del tasto "M" permette di selezionare il modo di funzionamento desiderato.</p> 		<p>I modi di funzionamento si attivano nella seguente sequenza:</p>  <p>Trascorsi 30" dall'ultima pressione del tasto "M", la sequenza di attivazione dei modi di funzionamento riparte dall'inizio in modo da rendere più rapido il passaggio da una qualsiasi modalità a quella Comfort.</p>
Icona	Descrizione	Quando utilizzare
	Comfort	Quando si è a casa. Il prodotto funziona per mantenere la temperatura di comfort desiderata.
	Eco	Quando si è fuori casa per brevi periodi (da 2 a 48 ore) o si dorme. Il prodotto funziona per mantenere la temperatura di eco desiderata e risparmiare energia.
	Antigelo	Quando si è fuori casa per un lungo periodo (oltre le 48 ore). La temperatura è automaticamente impostata a $7\pm 3^{\circ}\text{C}$ e non può essere modificata.

	Programma P1	Quando si desidera un funzionamento programmato preimpostato adatto a chi lavora fuori casa. QUESTO PROGRAMMA PUO' ANCHE ESSERE PERSONALIZZATO SEGUENDO LE ISTRUZIONI RIPORTATE NEL PARAGRAFO 6.2.6.
	Filo pilota	Quando si controlla il funzionamento del prodotto tramite una centralina esterna a filo pilota.

6.2.3.1 Descrizione dei programmi preimpostati

	Lunedì-Venerdì  Sabato-Domenica 
■ = temperatura "COMFORT" □ = temperatura "ECO" * = temperatura antigelo	

Il programma P1 può essere personalizzato seguendo le istruzioni riportate nel paragrafo 6.2.6.

Per impostare le temperature (valido per tutti i programmi):

- Selezionare il modo di funzionamento Comfort e regolare la relativa temperatura;
- Selezionare il modo di funzionamento Eco e regolare la relativa temperatura;
- Selezionare il programma P1.







Nota bene: Qualora si selezioni il programma P1 senza aver mai precedentemente impostato il giorno e l'ora correnti, il sistema entrerà automaticamente nella modalità di regolazione illustrata nel paragrafo 6.2.5.

6.2.3.2 Uso del filo pilota

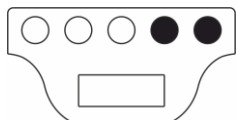

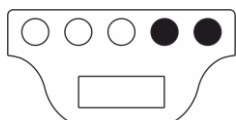



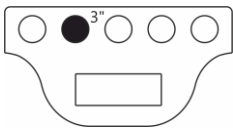

Se dotato di cavo di connessione senza spina il prodotto può essere anche comandato attraverso specifici programmatori. La temperatura di comfort utilizzata in modalità Filo Pilota va regolata, come già visto per i programmi preimpostati, posizionandosi preventivamente in modalità Comfort con il tasto "M" e selezionando il valore desiderato usando i tasti "+" e "-".

Nota bene: In modalità Filo Pilota, la temperatura di Eco è sempre quella di Comfort ridotta di 3,5°C.

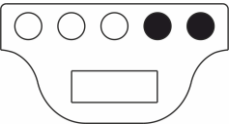
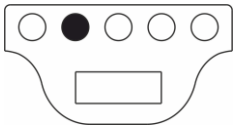
6.2.4 Regolazione della temperatura

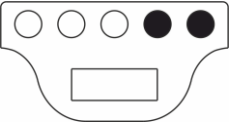
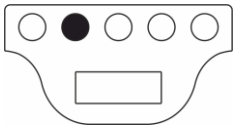
<p>Il prodotto è caratterizzato da 2 temperature di riferimento, comfort ed eco, regolabili in modo indipendente.</p>		Una freccia sul lato destro del display si muove lungo una scala colorata dal verde al rosso per indicare se la temperatura impostata è più o meno distante dal valore consigliato di 19°C.
<p>Il valore predefinito della temperatura di comfort è 19,0°C e può essere variato premendo i tasti "+" o "-".</p> 		Se la temperatura di comfort viene regolata ad un valore inferiore alla temperatura di eco, quest'ultima viene automaticamente reimpostata al valore di comfort - 0,5°C.
<p>Il valore predefinito della temperatura di eco è 15,5°C e può essere variato premendo i tasti "+" o "-".</p> 		La differenza consigliata fra i valori delle temperature di comfort ed eco è di 3,5°C. Qualora si impostino differenze diverse dal valore suggerito, il simbolo eco si modifica nel seguente modo:  Il valore massimo impostabile per la temperatura di eco è pari al valore della temperatura di comfort - 0,5°C.
<p>Se la temperatura ambiente è inferiore alla temperatura richiesta e visualizzata, sul display si accende l'indicatore di riscaldamento .</p>		

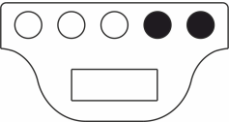
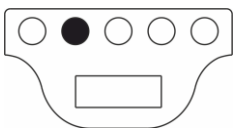
6.2.5 Impostazione del giorno e dell'ora



<p>La regolazione del giorno e dell'ora per poter utilizzare i 3 programmi predefiniti è attivabile mediante la pressione prolungata del tasto mode.</p> 		<p>Sul display lampeggia il giorno da impostare (1 = lunedì). Per modificarlo premere i tasti "+" o "-".</p> 
<p>Premere il tasto mode per confermare il giorno impostato e passare alla regolazione dell'ora.</p> 		<p>Sul display lampeggia l'ora da impostare. Per modificarla premere i tasti "+" o "-".</p> 
<p>Premere il tasto mode per confermare l'ora impostata e passare alla regolazione dei minuti.</p> 		<p>Sul display lampeggiano i minuti da impostare. Per modificarli premere i tasti "+" o "-".</p> 
<p>Premere il tasto mode per confermare i minuti impostati e concludere l'operazione di regolazione.</p> 		<p>Il sistema ritorna nel medesimo modo di funzionamento attivo nel momento in cui si è iniziata la regolazione.</p> <p>Provando ad attivare un programma preimpostato, senza aver prima memorizzato la data e l'ora, questa procedura di regolazione verrà attivata automaticamente.</p>







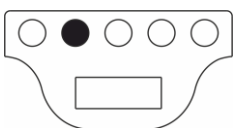

6.2.6 Personalizzazione del programma P1

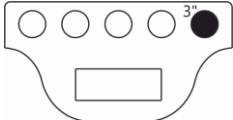

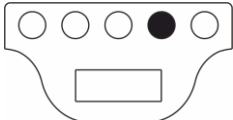
Il programma P1 può essere modificato per soddisfare al meglio le esigenze dell'utente. La modifica si basa sulla possibilità di impostare, per ogni ora del giorno e per tutti i giorni della settimana in modo indipendente, la temperatura desiderata scegliendo fra quella di comfort, quella di eco o quella di antigelo.

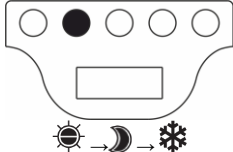
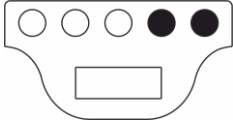
Per la definizione delle temperature associate ai diversi modi di funzionamento fare riferimento al paragrafo 6.2.4.

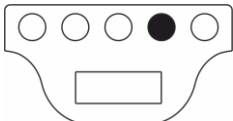
Quando si accede alle diverse ore del giorno per poterle visualizzare e/o modificare, su display viene indicata la temperatura impostata per il programma P1 attualmente valido. Se il prodotto è nuovo il profilo predefinito per il programma P1 è quello indicato al paragrafo 6.2.3.1. Per visualizzare o modificare il programma P1 procedere come segue:

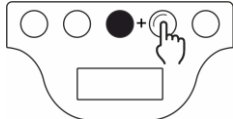

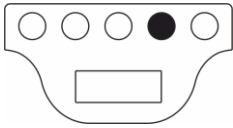

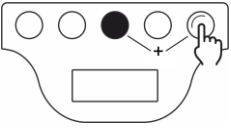



<p>Selezionare il programma P1 utilizzando il tasto "M".</p> 		<p>Qualora l'orario non sia impostato (prodotto nuovo o non alimentato per più di 30min) verrà attivata automaticamente la procedura di regolazione (vedere paragrafo 6.2.5)</p>
--	---	--

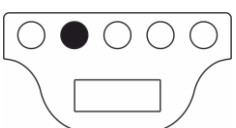

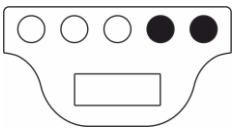

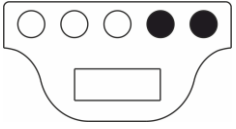

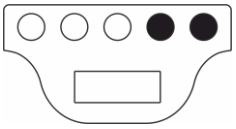



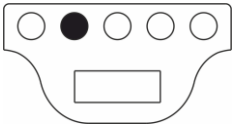

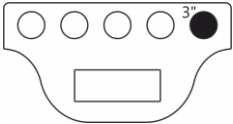

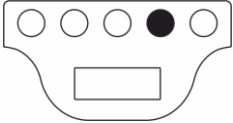

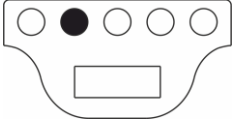

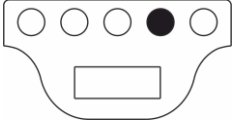
<p>Attivare la visualizzazione del programma P1 mediante la pressione prolungata del tasto "-".</p> 		<p>Il display indica il primo giorno da visualizzare/modificare (1 = lunedì)</p>
<p>Premendo una volta il tasto "+" si accede alla prima ora da visualizzare/modificare.</p> 		<p>Usare il tasto "M" per scegliere la temperatura desiderata fra comfort, eco e antigelo:</p>  <p>La temperatura inizialmente visualizzata quando si seleziona un'ora specifica è quella al momento definita per il programma P1 in corso di validità.</p>
<p>Usare i tasti "+" e "-" per accedere a tutte le ore del giorno 1 e visualizzare/modificare la temperatura di funzionamento per ognuna di esse.</p> 		<p>L'ora indicata è sempre quello iniziale. La regolazione delle ore 23, per esempio, riguarda la fascia oraria 23:00 → 24:00.</p>
<p>Dopo aver regolato la temperatura delle ore 23:00 per il giorno 1, un'ulteriore pressione del tasto "+" permette di accedere alla visualizzazione/modifica del giorno 2.</p> 		<p>Premendo il tasto "+" è possibile visualizzare/modificare la temperatura di funzionamento per ogni ora del giorno 2 come già descritto per il giorno 1.</p> <p>Per impostare automaticamente il nuovo giorno uguale a quello precedente tenere premuto il tasto "F" e poi premere il tasto "+".</p>  <p>Nota bene: la funzione di copia è disponibile solo quando il display visualizza il numero del giorno che si desidera impostare (non un orario specifico) e rende la programmazione di tale giorno identica a quella del giorno precedente.</p>

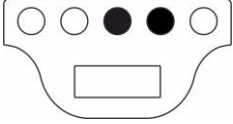
<p>Al termine della programmazione dell'ultimo giorno (giorno 7) la pressione del tasto "+" attiva la visualizzazione a display della scritta "END".</p> 		<p>Un' ulteriore pressione del tasto "+" permette di confermare la memorizzazione del programma.</p>
<p>L'indicazione "OK" visualizzata sul display per 5sec conferma l'avvenuta registrazione con successo dei dati impostati. Il sistema è ora impostato per regolare la temperatura secondo le impostazioni del nuovo programma P1.</p>		<p>Nota: E' anche possibile uscire dalla modalità di programmazione in qualsiasi momento senza dover necessariamente visualizzare tutte le ore fino alla fine del giorno 7. Per farlo è sufficiente tenere premuto il tasto "F" e poi premere il tasto "+".</p> 
<p>Nota bene:</p> <ul style="list-style-type: none"> - In ogni momento è possibile abbandonare la procedura di visualizzazione/modifica cancellando le modifiche non ancora salvate premendo il tasto stand-by; - La funzione di ripristino delle impostazioni di fabbrica (vedere paragrafo 6.3) cancella eventuali programmi P1 personalizzati e ripristina il profilo predefinito; - In qualsiasi fase della programmazione, la mancata pressione di un qualsiasi tasto per almeno 90sec provoca l'annullamento della procedura di visualizzazione/modifica e il ritorno al programma P1 precedentemente valido ; - Durante la programmazione gli elementi riscaldanti vengono disattivati ed il radiatore non scalda. 		





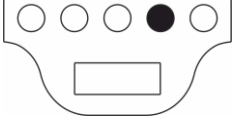





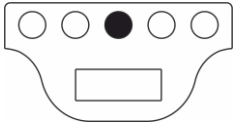

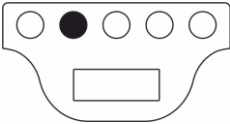
ESEMPIO DI MODIFICA DELLA PROGRAMMAZIONE

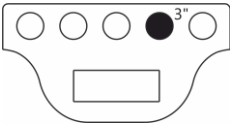

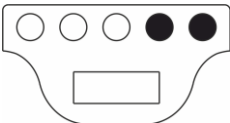

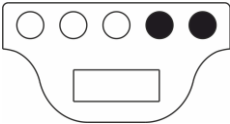

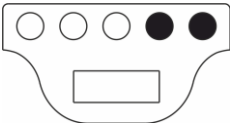
Ipotizziamo di aver appena acquistato il prodotto nuovo e di voler anticipare di un'ora il passaggio dalla temperatura di eco a quella di comfort (prevista dal programma predefinito alle ore 06:00) per tutti i giorni da lunedì a venerdì.

<p>Selezionare il programma P1 utilizzando il tasto "M"</p>		
<p>Impostare il giorno della settimana (poiché abbiamo ipotizzato che il prodotto sia nuovo) usando i tasti "+" e "-"</p>		
<p>Premere il tasto "M" e impostare l'ora corretta (poiché abbiamo ipotizzato che il prodotto sia nuovo) usando i tasti "+" e "-"</p>		
<p>Premere il tasto "M" e impostare i minuti corretti (poiché abbiamo ipotizzato che il prodotto sia nuovo) usando i tasti "+" e "-"</p>		

<p>Premere il tasto "M" per concludere la regolazione dei minuti. Il sistema torna in modalità programmazione con impostato il programma P1.</p>		
<p>Premere per almeno 3sec il tasto "-" per accedere alla visualizzazione/modifica del giorno 1.</p>		
<p>Premere il tasto "+" fino a visualizzare l'ora H:05 che desideriamo modificare cambiando la temperatura da eco a comfort</p>		
<p>Premere il tasto "M" 2 volte per cambiare la temperatura da eco a comfort</p>		
<p>Premere il tasto "+" fino a visualizzare sul display la scritta D: 2 rappresentativa dell'inizio della programmazione giorno 2</p>		
<p>Rendere il giorno 2 identico al giorno 1 tenendo premuto il tasto "F" e poi premendo il tasto "+". Il sistema si porta automaticamente all'inizio del giorno 3.</p>		
<p>Eeguire l'operazione di cui al punto precedente fino a rendere il giorno 5 uguale al giorno 4. Al termine il sistema si porta all'inizio del giorno 6.</p>		
<p>Dal momento che non si desidera modificare i giorni 6 e 7 è possibile uscire dalla modalità di programmazione tenendo premuto il tasto "F" e poi premendo il tasto "-". Sul display compare la scritta END.</p>		
<p>Premere il tasto "+" per ultimare la procedura. Sul display compare per 5" la scritta OK.</p>		

6.3 Funzioni speciali

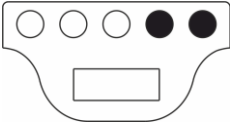
<p>La pressione progressiva del tasto “F” permette di selezionare in sequenza le varie funzioni speciali disponibili.</p> 		<p>L'uscita dal menù delle funzioni speciali può essere ottenuta semplicemente attendendo 12 secondi, oppure premendo il tasto “M” per tornare alla visualizzazione del modo di funzionamento.</p> 
<p>Ripristino delle impostazioni di fabbrica.</p> <p>Nota: il ripristino delle impostazioni di fabbrica NON cancella le impostazioni di connessione alla rete Wi-Fi eventualmente memorizzate.</p>		<p>Per reimpostare tutti i parametri del radiatore alle condizioni iniziali definite dal costruttore premere per almeno 3sec il tasto “+”.</p> 
<p>Wi-Fi</p> <p>Grazie a questa funzione, è possibile connettere il radiatore alla propria rete Wi-Fi dotata di accesso ad internet e controllarlo tramite l'App dedicata.</p> <p>Per maggiori dettagli fare riferimento al paragrafo 6.3.3.</p>		<p>L'attivazione (ON) o la disattivazione (OFF) della funzione si ottengono premendo rispettivamente i tasti “+” o “-”.</p>  <p>L'attivazione è indicata dalla relativa icona che si accende sul display </p>
<p>Sensore di presenza</p> <p>Grazie a questa funzione, il radiatore è in grado di identificare la presenza o meno di persone nel locale e regolare automaticamente il livello di riscaldamento per ottimizzare il comfort ed il risparmio energetico.</p> <p>Per maggiori dettagli fare riferimento al paragrafo 6.3.1.</p>		<p>L'attivazione (ON) o la disattivazione (OFF) della funzione si ottengono premendo rispettivamente i tasti “+” o “-”.</p>  <p>L'attivazione è indicata dalla relativa icona che si accende sul display </p>
<p>Sensore finestra aperta</p> <p>Questa funzione permette di identificare l'apertura di una finestra e di impostare automaticamente il modo di funzionamento antigelo.</p> <p>Per maggiori dettagli fare riferimento al paragrafo 6.3.2.</p>		<p>L'attivazione (ON) o la disattivazione (OFF) della funzione si ottengono premendo rispettivamente i tasti “+” o “-”.</p>  <p>L'attivazione è indicata dalla relativa icona che si accende sul display </p>

<p>Consumo giornaliero</p> <p>Questa funzione permette di visualizzare il consumo del radiatore nelle 24 ore precedenti.</p>		<p>Se l'indicazione del consumo lampeggia significa che i dati memorizzati sono relativi ad un periodo di tempo inferiore alle 24 ore.</p> <p>Nota bene: il display visualizza un consumo stimato che può differire da quello misurato con strumenti specifici adeguati a tale scopo.</p>
<p>Consumo settimanale</p> <p>Questa funzione permette di visualizzare il consumo del radiatore nei 7 giorni precedenti.</p>		<p>Se l'indicazione del consumo lampeggia significa che i dati memorizzati sono relativi ad un periodo di tempo inferiore ai 7 giorni.</p> <p>Nota bene: il display visualizza un consumo stimato che può differire da quello misurato con strumenti specifici adeguati a tale scopo</p>
<p>Visualizzazione della temperatura ambiente</p>		<p>Viene visualizzata sul display la temperatura ambiente misurata dal radiatore.</p>
<p>Allineamento della temperatura ambiente</p> <p>Questa funzione permette di modificare la temperatura ambiente misurata dal radiatore ed utilizzata per gestire la potenza riscaldante, qualora essa necessiti di essere corretta per compensare errori di lettura dovuti, per esempio, alla vicinanza con altre fonti di calore o alla presenza di spifferi di aria fredda.</p>		<p>Sul display lampeggia il valore di correzione da applicare. Per modificarlo premere i tasti "+" o "-".</p>  <p>Se ad esempio, la temperatura impostata sul radiatore è 19,2°C e nell'ambiente si misurano 19,5°C effettuare un allineamento pari a +0,3°C.</p>  <p>Attendere sempre almeno 4 ore per far stabilizzare le temperature prima di eseguire un eventuale allineamento.</p>

6.3.1 Sensore di presenza

Grazie a questa funzione, il radiatore è in grado di identificare la presenza o meno di persone nel locale e regolare automaticamente il livello di riscaldamento per ottimizzare il comfort ed il risparmio energetico.

Grazie a questa funzione, attivabile esclusivamente in modalità Comfort, il prodotto esegue un monitoraggio continuo della stanza e, qualora non rilevi la presenza di persone, riduce la temperatura di comfort impostata nel seguente modo:

Periodo di assenza	Riduzione della temperatura di comfort	Indicazione sul display
60 min	1,0°C	I simboli del sensore di presenza e della modalità comfort lampeggiano contemporaneamente 
90 min	2,0°C	
120 min	3,5°C	
38 ore	Attivazione Antigelo 7±3°C	

La riduzione della temperatura di riferimento è sempre riferita alla temperatura di comfort. Se il prodotto si trova in modalità Eco o Antigelo, non si osserverà nessuna variazione della temperatura da mantenere nel locale. Qualora venga rilevata nuovamente la presenza nel locale per almeno 10 minuti consecutivi, la temperatura di riferimento verrà automaticamente impostata uguale alla temperatura di comfort senza nessuna riduzione. Lo stesso avviene se durante il periodo di riduzione della temperatura desiderata, dovuto all'assenza di persone nel locale, viene premuto il tasto "M".

Importante:

Il corretto funzionamento di questa funzione può dipendere dal posizionamento del prodotto nel locale. Per scegliere la migliore posizione per l'installazione tenete presente che il sensore rileva i movimenti all'interno dell'area indicata in figura 9 e che non devono esserci oggetti che possano interferire. Il rilevamento della presenza inoltre è più efficace quando le persone si muovono davanti al sensore rispetto a quando si muovono verso di esso.

6.3.2 Sensore finestra aperta

Questa funzione permette di identificare l'apertura di una finestra e di impostare automaticamente il modo di funzionamento Antigelo.

Qualora venga rilevata una brusca riduzione della temperatura durante il normale funzionamento del prodotto, viene attivata automaticamente la modalità antigelo per ridurre lo spreco di energia. Sul display lampeggiano insieme il simbolo della finestra e dell'antigelo mentre il simbolo del modo di funzionamento impostato dall'utente rimane acceso fisso.

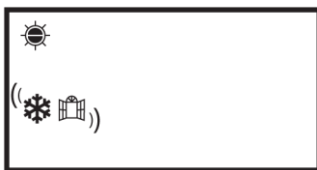

Il ripristino del normale funzionamento non è automatico ma si ottiene premendo il tasto "M".





Importante:

Il corretto funzionamento di questa funzione può dipendere dal posizionamento del prodotto del locale, dalla presenza di spifferi, dalla temperatura esterna e dal tempo di apertura della finestra.

6.3.3 Utilizzo della APP

Grazie a questa funzione, è possibile connettere il radiatore ad una rete Wi-Fi dotata di accesso ad internet e controllarlo tramite l'App Radialight® dedicata.

Per connettere il prodotto alla rete Wi-Fi è possibile seguire le istruzioni fornite direttamente nella app oppure consultare la guida dettagliata che illustra passo-passo la procedura. Scegli la guida relativa al tuo sistema operativo:

	android	🍏 iOS
SCARICA LA APP	 www.radialight.com/app-android	 www.radialight.com/app-ios
APRI LA GUIDA RAPIDA ALLA CONFIGURAZIONE	 www.radialight.com/android-start-guide	 www.radialight.com/ios-start-guide

Una volta ultimata la connessione, sulla App viene visualizzata la seguente pagina iniziale:



Elenco prodotti: permette di visualizzare l'elenco di tutti i prodotti registrati e di aggiungerne di nuovi. Per ogni prodotto viene visualizzato il nome, la modalità di funzionamento attiva, il nome della zona a cui appartiene e l'indicatore di riscaldamento. Ulteriori opzioni consentono di cambiare la zona di appartenenza, modificare il nome del prodotto o spegnerlo. Trascinando da destra verso sinistra l'icona del prodotto si scopre un tasto che permette di cancellarlo ed eliminarlo così dall'elenco dei prodotti gestiti.

Modo di funzionamento attivo: un'icona rappresenta il modo attivo utilizzando la medesima simbologia presente sul display del prodotto. Se è attiva la modalità programmata il simbolo dell'orologio è affiancato da quello della modalità di funzionamento prevista per il giorno e l'ora corrente. Alla destra di tale simbolo viene inoltre riportato il nome del programma attivo.

Consumo degli ultimi 7 giorni: Viene visualizzato il consumo energetico degli ultimi 7 giorni e rappresentato graficamente l'andamento dei consumi per ogni singolo giorno. Premendo sul grafico si accede alla sezione di analisi dei consumi.

Nome della zona: indica il nome che è stato assegnato alla zona e che può essere personalizzato seguendo le istruzioni che verranno riportate nel seguito.

Gestione delle zone: consente di visualizzare l'elenco di tutte le zone definite nonché di cancellarle o crearne di nuove. Per ogni zona vengono indicati il nome e il modo di funzionamento attivo ed è reso disponibile il pulsante per modificare il modo di funzionamento di tutti i prodotti della zona.

Programmazione: premendo questa icona si accede alla sezione relativa alla programmazione settimanale. In tale sezione è possibile modificare il programma predefinito proposto oppure crearne di nuovi. Ad ogni programma è possibile associare un nome ed un colore personalizzati per facilitarne l'identificazione. La cancellazione di un programma può essere fatta trascinando da destra verso sinistra l'icona del programma.

Consumi: premendo questa icona si accede alla sezione di analisi dei consumi con la possibilità di visualizzare i dati raccolti su base giornaliera, settimanale o mensile e divisi per zona o aggregati.

Scelta del modo di funzionamento: consente di selezionare il modo di funzionamento scegliendo fra Comfort, Eco, Antigelo, Programmazione, Filo pilota e Stand-by. Se lo si desidera è possibile temporizzare tale variazione: al termine del tempo impostato il modo attivo tornerà ad essere quello esistente prima della modifica.

Nome del prodotto: Il nome del prodotto viene visualizzato al centro del display. Nel caso in cui una zona includa più prodotti, le relative informazioni (nome e temperatura ambiente) vengono mostrate in sequenza.

Temperatura della stanza: viene visualizzata la temperatura misurata all'interno della stanza dal sensore installato sul prodotto.

Impostazioni: in questa sezione è possibile:

- Visualizzare il tutorial che spiega il funzionamento della App;
- Attivare il controllo dei costi che permette di affiancare al valore in kWh dell'energia utilizzata, anche un valore economico specificando il costo unitario dell'energia;
- Gestire l'invio di una notifica qualora la funzione di identificazione dell'apertura di una finestra sia abilitato ed entri in funzione;
- Gestire l'invio di una notifica qualora uno o più prodotti risultino in Stand-by mentre la zona a cui appartengono prevede una modalità differente;
- Gestire l'invio di una notifica al superamento di una soglia di consumo o di spesa preimpostata;
- Modificare la password dell'account;
- Modificare il consenso relativo alla ricezione di aggiornamenti e promozioni.

Premendo al centro della zona si accede alla visualizzazione di dettaglio delle impostazioni della zona:



Sensore finestra aperta: permette di attivare o disattivare il rilevamento dell'apertura di una finestra (vedere sezione 6.3.2).

Sensore di presenza: permette di attivare o disattivare la funzione di riduzione della temperatura di Comfort qualora la stanza non sia occupata per un determinato periodo (vedere sezione 6.3.1).

Blocco comandi: consente di bloccare i tasti di regolazione sul prodotto ed evitare modifiche accidentali o non autorizzate (vedere sezione 6.4).

Elenco prodotti della zona: tutti i prodotti appartenenti alla zona selezionata vengono elencati nella parte bassa dello schermo e di ognuno vengono indicati il nome, la modalità di funzionamento attiva e lo stato di riscaldamento.

Indicatore di riscaldamento: l'icona si accende quando la temperatura ambiente è inferiore a quella desiderata e il prodotto è in funzione per riscaldare la stanza.

Opzioni prodotto: consentono di cambiare la zona di appartenenza, modificare il nome del prodotto o spegnerlo.

Personalizzazione zona: permette di modificare il nome e l'immagine di sfondo che rappresentano la zona.

Incongruenze

Se una zona contiene 2 o più prodotti e uno o più di essi hanno una impostazione diversa da quella prevista per la zona si verifica una incongruenza.

Questa situazione, tipicamente legata alla modifica manuale delle impostazioni di un prodotto, può riguardare il modo di funzionamento, lo stato dei sensori o il valore delle temperature di Comfort e di Eco.

Qualora si verifichi questa condizione, la App evidenzia il parametro che risulta incongruente all'interno della zona, tramite la visualizzazione di un apposito simbolo come illustrato nella figura a lato.

Il medesimo simbolo appare anche nell'angolo superiore sinistro dell'icona del prodotto visibile nell'elenco in basso. In questo modo viene indicato all'utente qual è il prodotto che risulta avere una o più impostazioni non congruenti a quelle definite per la zona.

Premendo il simbolo di incongruenza è possibile reimpostare tutti i prodotti con i parametri precedentemente selezionati per la zona.

Se la modifica delle impostazioni di uno o più prodotti è stata intenzionale è possibile ignorare i simboli che vengono visualizzati. Tuttavia, se l'uso di impostazioni diversificate fosse ricorrente, si consiglia di assegnare i prodotti a zone differenti in modo da poterli gestire senza la visualizzazione continua dei simboli di incongruenza.

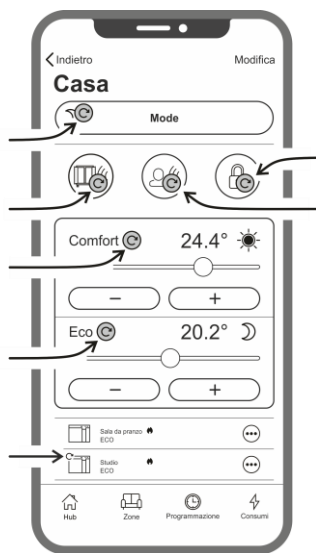

È bene sapere che:

Gestione dell'orario

L'impostazione dell'orario corrente e del giorno della settimana viene trasmessa al radiatore nel momento della sua registrazione iniziale. Contestualmente viene memorizzato il fuso orario della zona in cui si trova installato il prodotto.

La gestione dell'ora legale non è automatica ma basterà inviare un qualsiasi comando alla zona dopo il cambio dell'ora per fare in modo che i prodotti appartenenti alla zona vengano reimpostati con l'orario corretto.

Mancanza prolungata di alimentazione

In caso di assenza dell'alimentazione superiore ai 30min il radiatore perde molte delle sue impostazioni interne. Al ritorno dell'alimentazione il prodotto si ricollega automaticamente alla rete Wi-Fi e imposta la modalità Stand-by. Si raccomanda pertanto di controllare i dettagli della zona per verificare se la modalità impostata sulla App e quella presente sul prodotto risultano congruenti. Nella sezione impostazioni è possibile attivare l'invio di una notifica qualora vengano rilevati prodotti in modalità Stand-by che appartengono a zone per le quali è prevista una modalità differente.

Notifiche









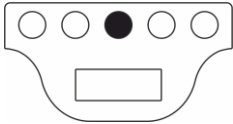

Nella sezione impostazioni è possibile definire se si desidera o meno ricevere delle notifiche al verificarsi di specifici eventi. Le notifiche vengono visualizzate, sia con App aperta che chiusa, se sono state autorizzate in fase di installazione della App. Per verificare lo stato di attivazione delle notifiche fate riferimento alle istruzioni del sistema operativo del vostro smartphone.

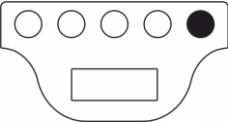
Potenza del segnale Wi-Fi

Se il radiatore è stato installato in una zona in cui il segnale della vostra rete Wi-Fi è debole o di intensità variabile è possibile che riscontriate una certa lentezza nell'esecuzione dei comandi inviati tramite App o addirittura la temporanea interruzione delle comunicazioni. Per risolvere il problema è necessario potenziare l'intensità del segnale nell'area di installazione.

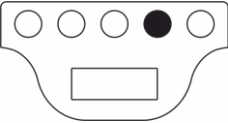
Gestione del modulo Wi-Fi

Il modulo Wi-Fi può essere acceso, spento o riportato in modalità Access Point in funzione delle proprie necessità.

<p>Per spegnere il modulo Wi-Fi premere il tasto "F" fino a visualizzare la scritta WiFi sul display.</p> 		<p>Premere il tasto "-" per spegnere il modulo.</p>  <p>Lo spegnimento dell'icona  conferma la corretta esecuzione del comando.</p>
<p>Per accendere il modulo Wi-Fi premere il tasto "F" fino a visualizzare la scritta WiFi sul display.</p> 		<p>Premere il tasto "+" per accendere il modulo.</p>  <p>L'accensione dell'icona  conferma la corretta esecuzione del comando.</p>
<p>Per riportare il modulo Wi-Fi alle condizioni di fabbrica e pronto per la configurazione iniziale premere il tasto "F" fino a visualizzare la scritta WiFi sul display.</p> 		<p>Premere il tasto "+" per 3" per resettare il modulo.</p>  <p>La visualizzazione a display della scritta "AP" conferma il ripristino delle impostazioni iniziali di fabbrica.</p>





Lo stato del modulo Wi-Fi è rappresentato sul display tramite una piccola icona sul lato destro.

Wi-Fi ACCESO e CONNESSO AL SERVER	simbolo acceso fisso	
Wi-Fi ACCESO ma NON CONNESSO A UNA RETE o CONNESSO A UNA RETE SENZA COLLEGAMENTO INTERNET	simbolo acceso lampeggiante	
Wi-Fi ACCESO e pronto per la configurazione iniziale	simbolo acceso lampeggiante e scritta AP visibile nel menu dedicato al Wi-Fi	
Wi-Fi SPENTO	simbolo non visibile	

Nota: Dopo l'accensione del prodotto, il collegamento con la rete Wi-Fi e con la App richiede un tempo di attesa di almeno 30". Se l'operazione non va a buon fine il simbolo del Wi-Fi lampeggia e la App mostra il prodotto come disconnesso. In tal caso è necessario spegnere il radiatore per almeno 30" prima di riprovare.

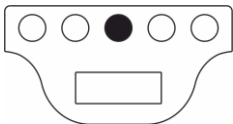
Consultare il paragrafo 7 per la risoluzione dei problemi più comuni e la spiegazione dei codici di errore.

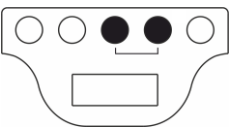
6.4 Utilità

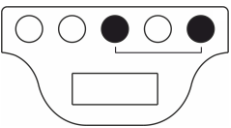
<p>Blocco comandi</p> <p>E' possibile bloccare i comandi del radiatore per evitare che le regolazioni possano essere modificate accidentalmente o da persone non autorizzate.</p> <p>Per entrare nella modalità di blocco/sblocco tenere premuto il pulsante "F".</p> 		<p>Dopo aver visualizzato la scritta "LOC" sul display:</p> <p>Tenere premuto il tasto "F" e premere contemporaneamente il tasto "+" se si desidera bloccare i controlli:</p>  <p>L'attivazione è indicata dalla relativa icona che si accende sul display </p> <p>Tenere premuto il tasto "F" e premere contemporaneamente il tasto "-" se si desidera sbloccare i controlli:</p> 
--	---	---

Quando la funzione è attivata, nel caso il prodotto venga alimentato dopo una interruzione della tensione di rete superiore ai 30 minuti, si ha il ripristino dello stato attivo al momento dell'interruzione di tensione. Qualora fosse stato attivo il programma P1 viene invece attivato lo stato "antigelo" poiché è necessario reimpostare l'orario e il giorno della settimana prima di attivare nuovamente un programma.

7. Risoluzione dei problemi

Problema	Soluzione
Il radiatore non si accende.	Verificare che vi sia l'alimentazione di rete, che essa corrisponda ai dati di targa del prodotto (es. 230Vac 50Hz) e che l'interruttore generale posto sul lato destro del radiatore sia acceso (posizione "I").
Il radiatore non scalda.	Assicuratevi che il modo di funzionamento impostato sia quello che desiderate e, se state usando un programma predefinito, di non essere in una fascia oraria che preveda il funzionamento in Antigelo. Se la temperatura dell'ambiente è superiore a quella impostata è corretto che il radiatore non scaldi. In caso di dubbi, impostate la modalità Comfort ed una temperatura desiderata molto maggiore della temperatura ambiente per verificare il corretto funzionamento del radiatore.
Il radiatore scalda sempre.	Verificate che non sia stata impostata una temperatura desiderata troppo elevata o che non vi siano correnti d'aria che investono il prodotto alterando la misurazione della temperatura ambiente.
Il radiatore non scalda sufficientemente.	Verificate che non sia stata impostata una temperatura desiderata troppo bassa, che il radiatore stia scaldando il solo locale in cui è installato (tenete chiuse le porte) e che l'alimentazione di rete sia corretta.
Il radiatore scalda in modalità Eco.	E' possibile che il radiatore scaldi per raggiungere/mantenere la temperatura di eco. Questo non è un funzionamento anormale.

<p>La superficie del radiatore è molto calda.</p>	<p>E' normale che la superficie sia calda durante il funzionamento. I valori massimi rispettano i limiti previsti dalle norme di sicurezza applicabili.</p> <p>Se il prodotto è sempre molto caldo è possibile che sia sottodimensionato per l'ambiente in cui lo si usa oppure sia condizionato da correnti d'aria o spifferi.</p>
<p>La temperatura del locale è diversa dalla temperatura impostata.</p>	<p>Dopo aver atteso la stabilizzazione della temperatura ambiente per almeno 4 ore, è possibile compensare eventuali differenze fra la temperatura indicata sul radiatore e quella rilevata nel locale. A tale scopo fare riferimento a quanto riportato nel paragrafo 6.3 nella sezione intitolata "Allineamento della temperatura esterna".</p>
<p>Il radiatore emette un odore sgradevole.</p>	<p>Quando il radiatore è nuovo è possibile che nei primi minuti di funzionamento emetta un odore sgradevole dovuto a residui di lavorazione nel processo di costruzione. Prodotti già utilizzati possono emettere un odore sgradevole se non vengono utilizzati da molto tempo e/o se vengono utilizzati in ambienti inquinati e con scarsa qualità dell'aria.</p>
<p>Impossibile visualizzare la rete Wi-Fi generata dal prodotto.</p>	<p>Posizionarsi con il proprio smartphone a una distanza dal prodotto non superiore ai 3m.</p> <p>La rete Wi-Fi generata dal prodotto viene visualizzata nelle impostazioni Wi-Fi dello smartphone e non all'interno della App.</p>
<p>Impossibile collegarsi alla rete Wi-Fi generata dal prodotto per iniziare la procedura di configurazione della App.</p>	<p>Qualora si abbiano più prodotti si raccomanda di accenderne e configurarne solo uno alla volta in modo da non confondersi con le diverse reti Wi-Fi generate.</p> <p>Accertarsi di aver inserito correttamente la password di rete che è Password123</p>
<p>Il dispositivo mobile si collega alla rete Wi-Fi creata dal prodotto ma la App mostra un messaggio che indica che nessun prodotto è stato trovato.</p>	<p>Non allontanarsi dal prodotto durante il collegamento e spegnere eventuali altre reti Wi-Fi alle quali lo smartphone potrebbe automaticamente collegarsi (esclusa quella a cui si desidera collegare il prodotto).</p> <p>Verificare sul display del prodotto che il modulo Wi-Fi sia attivo controllando che la relativa icona  sia accesa e lampeggiante. In caso contrario seguire le istruzioni per riportare il prodotto in modalità Access Point e riprovare.</p> <p>Se il Wi-Fi del prodotto risulta correttamente attivo chiudere la App, riaprirla ed eseguire l'aggiunta del nuovo prodotto come prima operazione.</p>
<p>La App non visualizza nessuna rete Wi-Fi alla quale connettere il prodotto.</p>	<p>Accertarsi che la rete Wi-Fi alla quale si desidera collegare il prodotto sia accesa e che il segnale arrivi nella zona in cui è installato il prodotto.</p> <p>Verificare l'intensità del segnale nella zona in cui è installato il prodotto. Segnali troppo bassi o di intensità variabile possono creare problemi di comunicazione. In tal caso è necessario spostare il prodotto in una nuova posizione o potenziare il segnale della rete Wi-Fi a cui ci si deve collegare.</p>
<p>Dopo aver selezionato sulla App la rete Wi-Fi alla quale si desidera collegare il prodotto si riceve il messaggio "Il prodotto non riesce a connettersi alla rete"</p>	<p>Verificare di aver inserito la password di rete corretta.</p> <p>Premere il tasto Riprova fino a quando la procedura non va a buon fine.</p> <p>Se dopo vari tentativi la procedura non va a buon fine riportare il prodotto in modalità Access Point e spegnerlo per 1 minuto. Successivamente ripetere la procedura dall'inizio.</p>

In caso di problemi con il modulo Wi-Fi, sul display del prodotto viene visualizzato un codice di errore per aiutare l'utente a risolvere il problema:

Errore	Descrizione	Risoluzione del problema
E01	Il prodotto non riesce a connettersi alla rete Wi-Fi. La password inserita per connettersi alla rete Wi-Fi desiderata (non quella generata dal prodotto) è errata oppure la rete non è più disponibile o ha cambiato nome.	Ripetere la procedura di registrazione collegandosi alla rete Wi-Fi generata dal prodotto e attendere che la App mostri nuovamente l'elenco delle reti a cui è possibile collegarsi. Selezionare quella desiderata e reinserire la password corretta.
E02	Connessione internet assente.	Ripristinare la connettività Internet.
E03	Server Radialight non raggiungibile.	È possibile che siano in corso lavori di manutenzione del server. Solitamente non durano più di qualche ora. Attendere e verificare che l'errore non sia più segnalato e l'icona Wi-Fi abbia smesso di lampeggiare. Se il problema persiste eliminare dalla App il radiatore, riportare il Wi-Fi del prodotto in modalità Access Point e ripetere tutta la procedura di registrazione come se il prodotto fosse nuovo. Qualora l'errore si ripresentasse dopo aver correttamente completato la registrazione del prodotto significa che il segnale Wi-Fi ricevuto dal radiatore è troppo debole o variabile e non è possibile ripristinare la connessione. In questo caso spostare il radiatore in un'altra posizione o amplificare il segnale Wi-Fi.
E04	La registrazione del prodotto sui nostri server non è andata a buon fine.	Il prodotto viene automaticamente reimpostato in modalità Access Point per poter ripetere dall'inizio tutta la procedura di registrazione.
E05	Modulo Wi-Fi disconnesso.	Spegnere il prodotto con l'interruttore generale per 1min e poi riaccenderlo.
E06	Modulo WI-FI in errore.	Se il problema persiste riprovare lasciandolo spento per almeno 1 ora in modo da cancellare la memoria temporanea interna e poi riaccenderlo.

8. Manutenzione

- Questo prodotto non richiede particolare manutenzione.
- Vi raccomandiamo di pulire il prodotto ogni 6 utilizzando un panno asciutto.
- Qualora sia necessario riparare il prodotto contattate un centro di assistenza autorizzato.
- Se deve essere sostituito il cavo di alimentazione ricordatevi che deve obbligatoriamente essere utilizzato un cavo tipo 2x1,00 mm² o 3x1,00mm² H05V2V2-F HAR in funzione della versione acquistata. Questa operazione, sia per i cavi dotati di spina che non, deve essere eseguita da personale qualificato e mai dall'utente finale in modo da prevenire ogni rischio di danneggiamento e possibile pericolo.

9. Informazioni legali



Tutela dell'ambiente e riciclaggio

Affinché il vostro apparecchio non subisca danni durante il trasporto, esso è stato imballato con cura. Per contribuire alla tutela del nostro ambiente, vi chiediamo di smaltire in modo appropriato il materiale utilizzato per l'imballaggio dell'apparecchio.

Smaltimento degli apparecchi usati

Gli apparecchi che recano il contrassegno riportato a fianco non devono essere smaltiti insieme ai rifiuti urbani, ma vanno raccolti e smaltiti separatamente. Lo smaltimento degli apparecchi usati va eseguito a regola d'arte, in conformità con le prescrizioni e leggi vigenti localmente in materia.

IT - Informazioni obbligatorie per gli apparecchi per il riscaldamento d'ambiente locale elettrici

Identificativo del modello: KLIMA Wi-Fi					
Dato	Simbolo	Valore	Unità	Dato	Unità
Potenza termica				Tipo di potenza termica, solo per gli apparecchi per il riscaldamento d'ambiente locale elettrici ad accumulo (indicare una sola opzione)	
Potenza termica nominale	P_{nom}	(*) vedere Tab. 1	kW	controllo manuale del carico termico, con termostato integrato	no
Potenza termica minima (indicativa)	P_{min}	(*) vedere Tab. 1	kW	controllo manuale del carico termico con riscontro della temperatura ambiente e/o esterna	no
Massima potenza termica continua	$P_{max,c}$	(*) vedere Tab. 1	kW	controllo elettronico del carico termico con riscontro della temperatura ambiente e/o esterna	no
Consumo ausiliario di energia elettrica				potenza termica assistita da ventilatore	no
Alla potenza termica nominale	e_{lmax}	0,000	kW	Tipo di potenza termica/controllo della temperatura ambiente (indicare una sola opzione)	
Alla potenza termica minima	e_{lmin}	0,000	kW	potenza termica a fase unica senza controllo della temperatura ambiente	no
In modo stand-by	e_{lsb}	0,00049	kW	due o più fasi manuali senza controllo della temperatura ambiente	no
				con controllo della temperatura ambiente tramite termostato meccanico	no
				con controllo elettronico della temperatura ambiente	no
				con controllo elettronico della temperatura ambiente e temporizzatore	no
				con controllo elettronico della temperatura ambiente e temporizzatore	si
				Altre opzioni di controllo (è possibile selezionare più opzioni)	
				controllo della temperatura ambiente con rilevamento di presenza	si
				controllo della temperatura ambiente con rilevamento di finestre aperte	si
				con opzione di controllo a distanza	no
				con controllo di avviamento adattabile	no
				con limitazione del tempo di funzionamento	no
				con termometro a globo nero	no
Contatti	Ermete Giudici S.p.A. - via L. da Vinci 27 - 20090 Segrate (MI) Italia				

Tabella 1		KLIMA 7 Wi-Fi KLIMA 7 AS Wi-Fi	KLIMA 10 Wi-Fi	KLIMA 15 Wi-Fi	KLIMA 20 Wi-Fi
Potenza termica					
Potenza termica nominale	P_{nom}	0,750	1,000	1,500	2,000
Potenza termica minima (indicativa)	P_{min}	0,075	0,113	0,150	0,188
Massima potenza termica continua	$P_{max,c}$	0,750	1,000	1,500	2,000

ENGLISH

OPERATING INSTRUCTIONS

Before operating the heater, please read these instructions thoroughly to avoid damage and hazardous situations. Any use of this heater other than that stipulated in this instruction manual may cause fire, electric shock or injury, and voids all warranties.

Warranty does not apply to any defect, deterioration, loss, injury or damage caused by, or as a result of, the misuse or abuse of this heater. The rights dictated by State law are not prejudiced. None of the terms of this warranty are to be taken as excluding any conditions or warranties implied by State law, which cannot be excluded or modified.

Before any operation remove the packaging and check product integrity. In case of defects or damages do not try to repair it yourself but contact your dealer.

Do not let children play with the packaging and protect the environment by disposing of the packaging in accordance with the national regulations for waste processing.

1. For your safety

- ❑ This appliance is intended for normal household use and not for use in vehicles or on board ships or aircrafts.
- ❑ This appliance can be used by children aged from 8 years and above and persons with reduced physical, sensory or mental capabilities or lack of experience and knowledge if they have been given supervision or instruction concerning use of the appliance in a safe way and understand the hazards involved. Children shall not play with the appliance. Cleaning and user maintenance shall not be made by children without supervision.
- ❑ Children of less than 3 years should be kept away unless continuously supervised.
- ❑ Children aged from 3 years and less than 8 years shall only switch on/off the appliance provided that it has been placed or installed in its intended normal operating position and they have been given supervision or instruction concerning use of the appliance in a safe way and understand the hazards involved. Children aged from 3 years and less than 8 years shall not plug in, regulate and clean the appliance or perform user maintenance.
- ❑ **CAUTION: Some parts of this product can become very hot and cause burns. Particular attention has to be given where children and vulnerable people are present.**
- ❑ Make sure that the mains power supply matches the rated input: 230V AC, 50Hz.
- ❑ Never allow animals or children to play with or touch the product. Attention! The panel may become very hot while it is working (approximately 80°C=176°F);
- ❑ **WARNING: In order to avoid overheating, do not cover the heater.** Do not hang anything on the heater and do not cover it while

it's working. This is clearly written on the cover of the product or shown by the symbol



- ❑ Do not use the product in rooms saturated with explosive gas, vapours generated by solvents or paints or flammable vapours/gas.
- ❑ If the cable and/or plug are damaged, do not repair them yourself but take the product to the technical service or a qualified repair centre and have them repaired by specialised personnel in order to avoid any risk of damage.
- ❑ Always position the product so that the plug is immediately accessible.
- ❑ Never position this appliance immediately underneath a power socket.
- ❑ Do not insert objects or paper into the radiator.

2. Your product

- ❑ Other than the heater you have chosen the package includes (picture 1):
 - N° 1 metal brackets for wall mounting (fixed to the radiator);
 - N° 4 nylon plug expansion 8x50mm;
 - N° 4 5x60mm cross head screws to fix wall brackets;
- ❑ Refer to your dealer if something is broken or missing.

3. Safe positioning

- ❑ Only use the product in its horizontal position;
- ❑ This product is fitted with a double electrical insulation circuit (class II) and therefore does not require an earth connection;
- ❑ Always make observe the minimum distances from walls, furniture and/or objects, as indicated in picture 2.
- ❑ Never install the product on a surface made from wood or synthetic material.
- ❑ This product is water resistant to IP24. It may therefore be used in bathrooms or other areas subject to humidity provided it is never installed within the perimeter of bathtubs or showers (Volume 1 of figure 2).
- ❑ Do not install the radiator in a draft that could disturb its regulation.

4. Installation

- ❑ Remove the wall-mounting bracket fixed to the back of the radiator, by releasing first the 2 upper springs and then the 2 lower springs as shown in figure 4.
- ❑ Rest the bracket on the floor to use it as a template to mark the points at which the two lower fixing holes are to be made (figure 5A).
- ❑ Lift the bracket until its lower fixing points coincide with the marks made on the wall before, and use a pencil to mark the position of the two upper fixing points (figure 5B).
- ❑ Drill the 4 holes at the points marked previously, and insert the plastic anchors (figure 6).
- ❑ Fix the bracket to the wall using the 4 screws supplied (figure 7).
- ❑ Hook the radiator to the bracket starting with the 2 lower fixing points, and then click the 2 upper fixing points into position (figure 8).
- ❑ Should you have to remove the radiator from the bracket at a later stage, we recommend releasing the lower two fixing points first and then the upper fixings.

5. Electrical connections

- ❑ The product must be powered at a voltage of 230V AC 50Hz.
- ❑ The product must be supplied with a cable and plug or with a cable for installation. If a product with plug is installed in France, connect it to the mains power supply by cutting off the plug and using a suitable connection box.
- ❑ If the product is supplied with a cable for installation without plug, connect it to the mains power supply using a 3-wire cable (Brown=Live, Blue=Neutral, Black=Pilot wire) and a connection box. **If you do not wish to use the pilot wire**

functions, just connect the phase and the neutral wires: the product will work correctly even without the external programmer.

- ❑ In bathrooms, kitchens or other humid areas, install the connection terminal at least 25cm off the floor.
- ❑ The electrical connection to the mains power supply must also include a 2-pole switch with a minimum contact aperture of 3mm. As a priority, always abide you national wiring rules.
- ❑ It is forbidden to connect the appliance to the earth circuit. **DO NOT CONNECT THE PILOT WIRE (BLACK) TO THE EARTH CIRCUIT.**
- ❑ If the product is powered through a 30mA differential switch, make sure the pilot wire is also controlled by the differential switch.

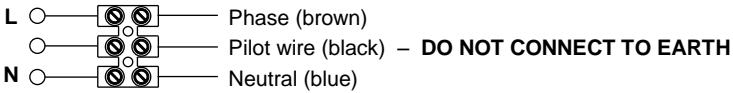

6. Using the product

6.1 Description of controls

- A – Switch on/Stand-by
- B – Operating mode
- C – Special functions
- D – Increase / Activate
- E – Decrease / Deactivate
- F – Display
- G – Main switch

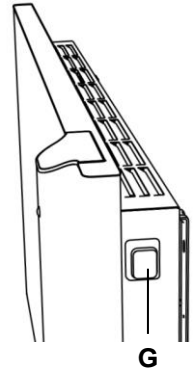
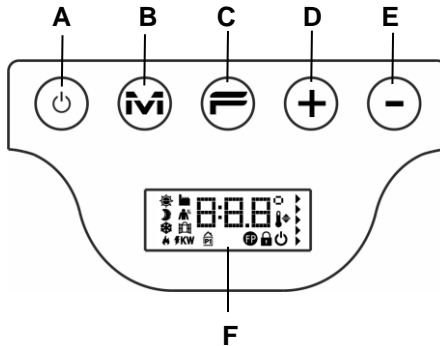

6.2 Operating

6.2.1 Switching on the screen

If the screen is not switched on, push any key to make it light up.
The screen lights up and stays on for 30 seconds after the last time any key is pushed.







When the screen is switched off, the first time any key is pushed the screen lights up without activating the function controlled by the key pushed.

6.2.2 Switching the radiator on and off

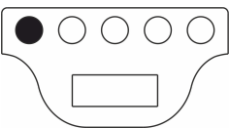

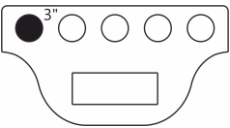

The power supply to the radiator is controlled by a two-pole electromechanical switch (G) located on the right side of the radiator. When this switch is used the power supply to the electronic board is also switched off and, as a result, all the parameters saved are lost after about 30 minutes, and the default settings are reinstated.

We recommend only using this switch if the radiator is not to be used for a long period of time, and to rather use the Switch on / Stand by button (A) for switching off for short periods, in order to avoid losing the settings saved.

<p>When the radiator is switched on using the main switch on its side, the display lights up and the stand-by symbol is displayed.</p>		
<p>To switch on the radiator, push the Switch on / Stand-by key.</p> 		<p>The radiator always comes on in comfort mode. If the radiator is new or the power supply has been off for more than 30 minutes, the comfort temperature is at the default value of 19°C.</p>
<p>To switch off the radiator, hold down the Switch on / Stand-by key for at least 3 seconds.</p> 		<p>Switching the radiator off using the rocking switch on its side for more than 30 minutes results in the loss of all data saved (date, time, temperature setting, etc.).</p>

6.2.3 Selecting the operating mode

<p>Pressing the "M" key repeatedly allows you to select the operating mode you require.</p> 		<p>The operating modes are activated in the following order:</p>  <p>Once 30" has elapsed since the "M" key was last pushed, the operating mode activation sequence begins from the beginning again, to make it quicker to switch from any mode to Comfort mode.</p>
---	---	--

Icon	Description	When used
	Comfort	When at home The radiator works to maintain the comfort temperature set.
	Eco	When you are away from home for short periods (from 2 to 48 hours) or you are sleeping. The radiator works to maintain the eco temperature set and save energy.
	Anti-freeze	When you are away from home for long periods (more than 48 hours). The temperature is automatically set at 7±3°C and cannot be changed.
	Programme P1	When you want preset programmed operation, suitable for those that do not work from home. THIS PROGRAM CAN ALSO BE CUSTOMIZED FOLLOWING THE INSTRUCTIONS LISTED IN PARAGRAPH 6.2.6.
	Pilot wire	When checking operation of the radiator, using an external control unit with a pilot wire.

6.2.3.1 Description of preset programmes

	Monday-Friday Saturday-Sunday	00:00 06:00 08:00 12:00 14:00 17:00 24:00 □□□□□■ □□□□□□□□□□□□□□□□□□□□□□□□ □□□□□□□■ □□□□□□□□□□□□□□□□□□□□□□□□
	■= temperature "COMFORT" □= temperature "ECO" *= temperature anti-freeze	

The program P1 can be customized following the instructions listed in paragraph 6.2.6.

To set the temperatures (valid for all programmes):

- Select Comfort operating mode and set the relevant temperature.
- Select Eco operating mode and set the relevant temperature.
- Select the program P1.

Please note: When you select programme P1 without ever having set the current date and time, the system will automatically switch to the regulation mode explained in paragraph 6.2.5.





6.2.3.2 Using the pilot wire

If a connection cable is supplied without a plug, the radiator can also be controlled using specific programmers.



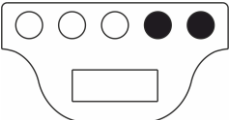

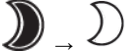



The comfort temperature used in Pilot Wire mode is set, as already explained for the preset programmes, by going to Comfort mode first, using the "M" key and then selecting the value required using the "+" and "-" keys.

Please note: In Pilot Wire mode, the Eco temperature is always equal to the Comfort temperature less 3,5°C.

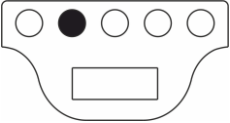
6.2.4 Setting the temperatures

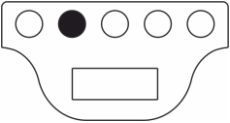
The radiator is characterised by 2 reference temperatures, comfort and eco, which can be set independently.		An arrow to the right of the display moves along a scale from green to red to indicate whether the temperature differs more or less from the recommended value of 19°C.
The preset comfort temperature is 19,0°C and can be changed using the "+" or "-" keys.		If the comfort temperature is set at a value lower than the eco temperature, the latter is automatically reset at the comfort value - 0,5°C.
The preset eco temperature is 15,5°C and can be changed using the "+" or "-" keys.		The recommended difference between the comfort and eco temperature values is 3,5°C. If the difference set differs from the suggested value, the eco symbol changes as follows: <div style="text-align: center; margin: 10px 0;">  </div> The maximum value that can be set for the eco temperature is equal to the comfort temperature value - 0,5°C.
If the ambient temperature is lower than the temperature required and displayed, the heating indicator switches on, on the display  .		

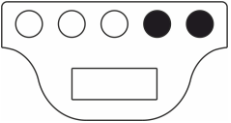
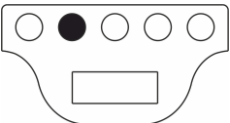
6.2.5 Setting the day and time

<p>The day and time are set to be able to use the 3 preset programmes, and this can be done by holding down the mode key.</p> 		<p>The day flashes the day to be set (1 = Monday). To edit it, push the "+" or "-" keys.</p> 
<p>Push the mode key to confirm the day set and move on to setting the time.</p> 		<p>The display flashes the hour to be set. To edit it, push the "+" or "-" keys.</p> 
<p>Push the mode key to confirm the hour set and move on to setting the minutes.</p> 		<p>The display flashes the minutes to be set. To edit it, push the "+" or "-" keys.</p> 
<p>Push the mode key to confirm the minutes set and conclude the setting operation.</p> 		<p>The system will go back to the operating mode activated when setting was started.</p> <p>If you try to activate a preset programme without having saved the date and time, this setting procedure will be activated automatically.</p>

6.2.6 Customizing P1 Program









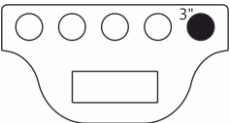
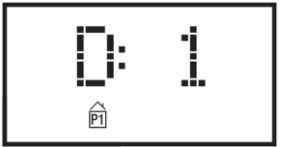
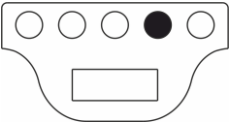

Program P1 may be modified to suit the users needs. Modification of P1 gives the user the opportunity to set the wished ambient temperature, choosing among Comfort, ECO or Frost Free, for every hour of the day and for the whole week.

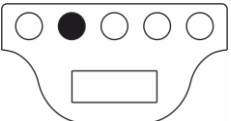
Please refer to paragraph 6.2.4 in order to set different levels of temperature to each working Mode.

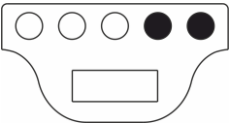
Each displayed hour of the day, shows the temperature level of P1 Program currently set. In case of first use of the radiator, the set P1 Program profile is the one indicated in Paragraph 6.2.3.1.

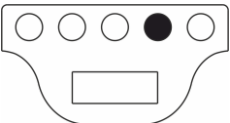
In order to display or modify P1 Program, please proceed as follows:

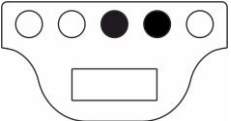
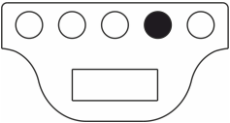
<p>Press "M" to select P1 Program.</p> 		<p>In case Time has not been set previously (brand-new product, or lack of power connection longer than 30 min.) the time regulation procedure will be activated automatically (refer to paragraph 6.2.5)</p>
---	---	---

<p>To display P1 Program hold button “-” for 3 seconds.</p> 		<p>The first day to see/modify is now displayed (1= Monday)</p>
<p>Press “+” button to enter the first hour to see/modify.</p> 		<p>Press “M” button to choose the wished temperature level among Comfort, Eco or Frost Free:</p>   <p>The displayed temperature once you've selected a specific hour of the day, is the one currently set on the P1 Program.</p>
<p>Use “+” and “-” buttons to enter each hour of day 1 and see/modify the working temperature of each of them.</p> 		<p>The hour displayed always indicates the starting point. For example: when H 23 is displayed the modification involves the period of time between 23:00 and 00:00.</p>
<p>Having modified the temperature for each of the 23 hours of Day 1, press further “+” button to enter the modification mode of Day 2.</p> 		<p>Press “+” button to display/modify the working temperature of each hour of Day 2, as described for Day 1. You can set automatically the same program of Day 1 on Day 2 by holding the “F” button and pressing “+” button.</p>  <p>Note: you are allowed to copy and paste the same daily program ONLY WHEN the number of the day you wish to adjust is displayed (as showed in the picture), BUT NOT when the hour is displayed.</p>
<p>Once the last day (Day 7) has been set, press “+” button to end the program sequence.</p> 		<p>END will appear on the display. A further pression of “+” button will allow you to confirm the adjusted program.</p>

“OK will appear on the display for 5 second, confirming that the Program sequence has been carried out successfully.
System is now set to adjust the temperature according to the new adjustment of program P1.



Note: it is possible to exit any time from the program sequence, without displaying every hour until Day 7. To do so, just hold “F” button and press “-” button.

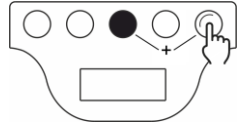









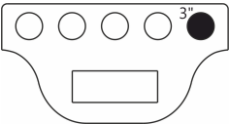

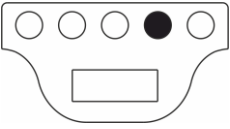

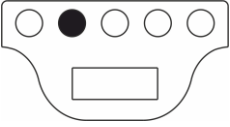

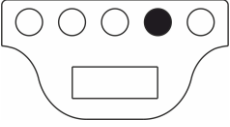

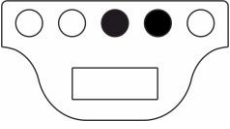
- N.B.:**
- You can abort the display/modification sequence anytime, deleting any settings that have not been saved, just by pressing “Stand-By” button;
 - Restoring the default settings will delete every P1 Program previously created (see paragraph 6.3);
 - If no button is pressed within 90 sec. during the Program setting process, the result will be the cancellation of the display/modification procedure and will restore back the factory default settings;
 - During the programming process, the heating elements will automatically switch to Stand-by mode, and the radiator does not heat.

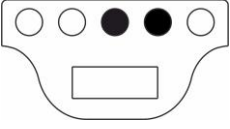



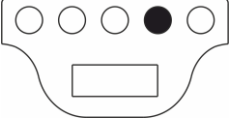





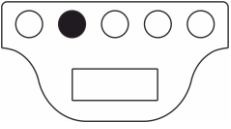

EXAMPLE: HOW TO SET A CUSTOM PROGRAM

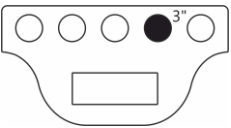

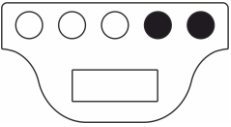

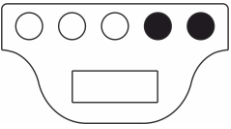

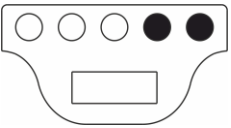
Let's see how to program a brand-new radiator, and anticipate the change from ECO to COMFORT temperature one hour earlier (06:00 a.m. is the default factory settings), for each day from Monday to Friday.

<p>Press “M” to select Program P1</p>		
<p>Set the current day of the week (first use of the radiator) using “+” or “-” button.</p>		
<p>Press “M” and set the current Hour (first use of the radiator) using “+” or “-” button.</p>		
<p>Press “M” and set the current Minutes (first use of the radiator) using “+” or “-” button.</p>		
<p>Press “M” to end the time setting procedure. System now gets back to Program P1.</p>		

<p>Hold “-” for 3 sec. To enter the display/modification of Day 1.</p>		
<p>Press “+” until you'll see H:05 on the display (that's the hour we want to modify the ECO temperature level to COMFORT).</p>		
<p>Press “M” two times to change the ECO temperature level to COMFORT.</p>		
<p>Press “+” button until you'll see D:2 appear on the display (Tuesday)</p>		
<p>To copy and paste the same program of Day 1 on Day 2, hold “F” and press “+” button. The system will automatically copy the program and display directly Day 3 (Wednesday).</p>		
<p>Repeat the procedure previously described until D:6 appears on the display.</p>		
<p>Since we don't want to modify Day 6 and 7, we can exit the Program settings mode, holding “F” and pressing “-” button. “END” will appear on the display.</p>		
<p>Press “+” to confirm the modification process. “OK” will be flashing on the display for 5 sec.</p>		

6.3 Special functions

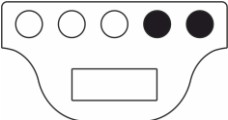
<p>Repeatedly pushing the "F" key makes it possible to select the various special functions available in sequence.</p> 		<p>To leave the special functions menu, simply wait 12 seconds, or push the "M" key to go back to viewing the operating mode.</p> 
<p>Reinstating default settings</p> <p>Note: Restoring the factory settings will NOT cancel any Wi-Fi connection setting previously saved.</p>		<p>To reinstate all the radiator's parameters to the default settings set by the manufacturer hold at least for 3sec the "+" key down.</p> 
<p>Wi-Fi</p> <p>Thanks to this feature, it is possible to connect the radiator to your Wi-Fi network with internet access and control it via App.</p> <p>For more details, refer to paragraph 6.3.3.</p>		<p>The activation (ON) or deactivation (OFF) of this feature are obtained by pressing respectively "+" or "-".</p>  <p>Activation is indicated by the relative icon lighting up on the display </p>
<p>Presence sensor</p> <p>This function allows the radiator to pick up whether or not people are in the space, and automatically regulate the heating level, in order to optimise comfort and energy saving.</p> <p>For further details see paragraph 6.3.1.</p>		<p>Switching the function (ON) or (OFF) is done by pushing the "+" or "-" keys respectively.</p>  <p>Activation is indicated by the relevant icon that switches on, on the display </p>
<p>Window open sensor</p> <p>This function makes it possible to detect an open window and automatically activate the anti-freeze operating mode.</p> <p>For further details see paragraph 6.3.2.</p>		<p>Switching the function (ON) or (OFF) is done by pushing the "+" or "-" keys respectively.</p>  <p>Activation is indicated by the relevant icon that switches on, on the display </p>

<p>Daily consumption</p> <p>This function makes it possible to view the power the radiator has consumed over the previous 24 hours.</p>		<p>If the consumption indication is flashing, this means that the data saved relates to a period of less than 24 hours.</p> <p>Please note: The display shows the estimated consumption, which may differ from that measured by specific meters, suitable for the purpose.</p>
<p>Weekly consumption</p> <p>This function makes it possible to view the power the radiator has consumed over the previous 7 days.</p>		<p>If the consumption indication is flashing, this means that the data saved relates to a period of less than 7 days.</p> <p>Please note: The display shows the estimated consumption, which may differ from that measured by specific meters, suitable for the purpose.</p>
<p>Displaying the ambient temperature</p>		<p>The display shows the ambient temperature measured by the radiator.</p>
<p>Alignment of the ambient temperature</p> <p>This function is used to edit the ambient temperature measured by the radiator and used to manage heating power, if it needs to be corrected to compensate for reading errors due to things like being near to heat sources, or cold air draughts.</p>		<p>The display flashes the correction value to be applied. To edit it, push the "+" or "-" keys.</p>  <p>If, for example, the temperature set on the radiator is 19,2°C and the ambient temperature is measured at 19,5°C, align it by +0,3°C.</p>  <p>Always wait at least 4 hours for the temperature to settle, before doing any alignment.</p>

6.3.1 Presence sensor

This function allows the radiator to pick up whether or not people are in the space, and automatically regulate the heating level, in order to optimise comfort and energy saving.

Thanks to this function, which can only be activated in Comfort mode, the radiator continuously monitors the room and, if no people are detected, it reduces the comfort temperature set as follows:

Period of absence	Reduction of the Comfort temperature	Indication on the display
60 min	1,0°C	<p>The presence sensor and comfort mode symbols flash together</p> 
90 min	2,0°C	
120 min	3,5°C	
38 hours	Anti-freeze activated 7±3°C	

The reduction in temperature always relates to the comfort temperature. If the radiator is in Eco or Anti-freeze mode, no change in temperature to be maintained in the room will be observed.

Should someone be detected in the room for at least 10 consecutive minutes, the temperature is automatically returned to the comfort temperature set, without any reduction. The same happens if, while the temperature required is being reduced, due to an absence of people being detected in the room, the "M" key is pushed.

Important:

Correct operation of this function may depend on where the radiator is positioned in the room. To choose the best installation position, bear in mind that the sensor detects movements within the area indicated in figure 9, and that no objects must be in its way. Presence detection is also more effective when people move in front of the sensor than when they move towards it.

6.3.2 Open window sensor

This function makes it possible to detect an open window and automatically activate the Anti-freeze operating mode.

If a sudden reduction in temperature is detected when the radiator is operating normally, anti-freeze mode is activated automatically to reduce energy wastage. On the display the window and anti-freeze symbols flash together, while the symbol for the operating mode set by the user stays on.



Reinstating normal operation does not occur automatically but must be activated by pushing the "M" key.





Important:

Correct operation of this function may depend on where the radiator is positioned in the room, the presence of draughts, the outside temperature, and how long the window stays open.

6.3.3 Using the APP

Thanks to this feature, it is possible to connect the radiator to a Wi-Fi network with internet access and control it via the dedicated Radialight® App.

To connect the product to the Wi-Fi network you can follow the instructions provided directly in the App or consult the detailed guide that illustrates the procedure step by step. Choose the guide for your operating system:

	android	iOS
DOWNLOAD THE APP	 www.radialight.com/app-android	 www.radialight.com/app-ios
OPEN THE QUICK START GUIDE	 www.radialight.com/android-start-guide	 www.radialight.com/ios-start-guide

Once the connection is completed, the following home page is displayed on the app:

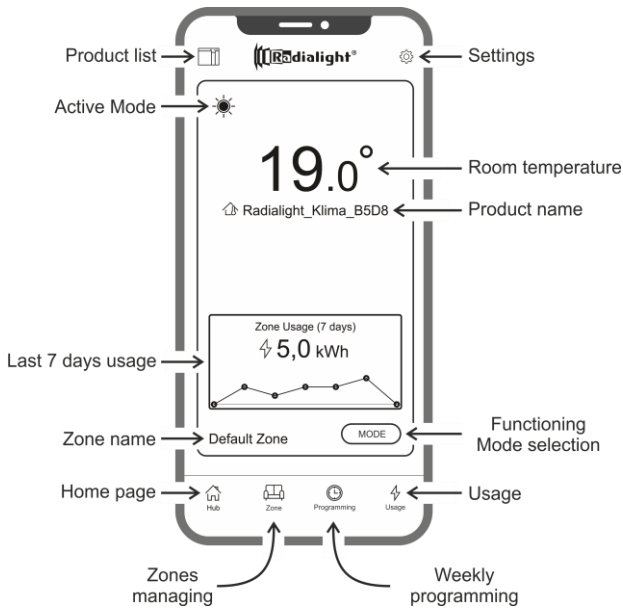

Product list: it allows you to view the list of all your registered products and to add new ones. The currently active mode of operation, the product zone name and the heating indicator are displayed for each product. Further options allow you to change the belonging zone, the product name and switch the product off. By dragging the product icon from right to left, you will find a button that allows you to delete it and erase it from the product list.

Active Mode: an icon represents the active mode using the same symbol on the product display. If the programmed mode is active, the clock symbol is flanked by the scheduled operating mode icon. The active program name too is shown to the right of this symbol.

Last 7 days usage: The energy consumption of the last 7 days is displayed and the consumption trend is graphically represented for each day. Pressing on the graph you access the section of usage analysis.

Zone name: it indicates the name assigned to the zone and can be customized following the instructions below.

Zone management: it allows you to view the defined zones list and to delete or create new ones. For each zone the name and active mode are indicated and it is available a key to change the operating mode of all the zone products.

Weekly programming: by pressing this icon you access the weekly programming section. In this section it is possible to modify the default preset program or to create new ones. Each program can be associated with a customized name and color to facilitate identification.

The cancellation of a program can be done by dragging the program icon from right to left.

Usage: by pressing this icon you can access the usage analysis section and view the data collected on a daily, weekly or monthly basis - divided by area or grouped.

Operating Mode selection: it allows you to select the operating mode choosing between Comfort, Eco, Antifreeze, Programmed, Pilot wire and Stand-by. If desired, this variation can be timed: at the end of the set time, the active mode will return to the one set before the change.

Product Name: The product name is shown in the center of the display. If a zone includes several products, the relevant information (name and room temperature) are shown in sequence.

Room temperature: the temperature measured by the product sensor is displayed.

Settings: in this section it is possible to:

- View the tutorial explaining how the App works;
- Activate cost control allowing to add to the kWh value an economic value too by specifying the unit cost of energy;
- Manage user notification if the open window sensor is enabled and goes into operation;
- Manage user notification if one or more products are in Standby mode while the zone they belong to are set to a different mode;
- Manage user notification if a set consumption or expense threshold is exceeded;
- Change the password of the account;
- Change of the updates and promotions receipt consent.

By pressing the center of the zone you can access the detailed zone settings view:

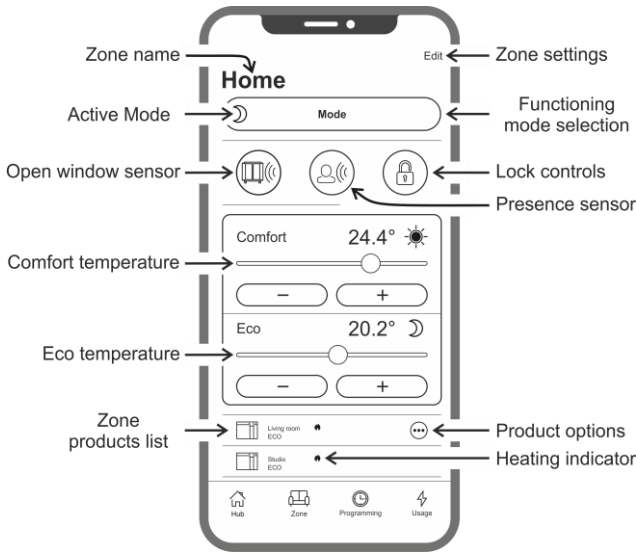

Open window sensor: it allows you to activate or deactivate the detection of the opening of a window (see section 6.3.2).

Presence sensor: it allows you to activate or deactivate the Comfort temperature reduction function if the room is not occupied for a certain amount of time (see section 6.3.1).

Lock controls: it allows you to lock the adjustment keys on the product preventing accidental or unauthorized changes (see section 6.4).

Zone products list: all the products belonging to the selected zone are listed at the bottom of the screen. Each one shows its name, the active operating mode and the heating status.

Heating indicator: the icon lights up when the room temperature is lower than desired and the product is operating to heat the room.

Product options: it allows you to change the zone of belonging, the product name or switch it off.

Zone settings: it allows you to change the zone name and background image.

Inconsistencies

If a zone contains 2 or more products and one or more of them have a different setting than the one set for the zone, an inconsistency occurs.

This situation, usually due to the manual modification of a product parameter, can relate to the operating mode, the sensors status or the Comfort and Eco temperature values.

If this condition occurs, the App highlights the inconsistent zone parameter by displaying a special symbol as shown in the picture on the right.

The same symbol appears in the upper left corner of the product icon shown in the list on the bottom of the screen. In this way, the user is informed of the product that results to have one or more settings that are not congruent with those defined for the zone.

By pressing the inconsistency symbol, it is possible to reset all the products with the parameters previously selected for the zone.

If the modification of the settings of one or more products was intentional it is possible to ignore the symbols that are displayed. However, if the use of diversified settings is recurrent, it is advisable to assign the products to different zones so as to be able to manage them without the continuous display of the inconsistency symbols.

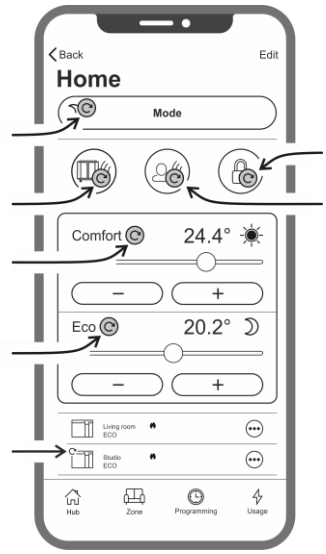

It is good to know that:

Time management

The current time and day of the week setting is transmitted to the radiator at the time of its initial registration. At the same time, the time zone of the area where the product is installed is stored.

The management of the daylight savings time is not automatic but it will be enough to send any command to the zone after the time change to make sure that the products belonging to the zone are reset with the correct time.

Power failure

If the power supply is disconnected for more than 30 minutes, the radiator loses many of its internal settings. When the power returns, the product automatically reconnects to the Wi-Fi network and sets the Stand-by mode. It is therefore recommended to check the details of the area to control whether the mode set on the App and the one present on the product are congruent. In the settings section it is possible to activate the user notification if products are detected in Stand-by mode while the zone they belong to are set to a different mode.

Notifications









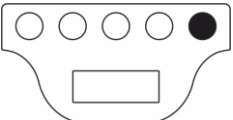

In the settings section you can define whether or not you want to receive notifications when specific events occur. Notifications are displayed, either with the app open or closed, if they have been authorized during the installation of the app. To check the activation status of the notifications, refer to the instructions of the operating system of your smartphone.

Wi-Fi signal strength



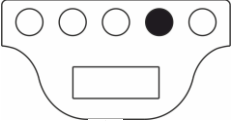

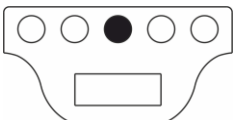
If the radiator has been installed in an area where the signal of your Wi-Fi network is weak it is possible that you experience a certain slowness in the execution of the commands sent via the App or even the temporary interruption of the communications. To solve the problem, it is necessary to increase the intensity of the signal in the installation area.

Wi-Fi module management:

The Wi-Fi module can be switched on, turned off or reported in access point mode according to your needs.

<p>To switch off the Wi-Fi module, press the "F" key until the word WiFi appears on the display.</p> 		<p>Press the "-" key to turn off the module.</p>  <p>Turning off the  icon confirms the correct execution of the command.</p>
<p>To switch on the Wi-Fi module, press the "F" key until the word WiFi appears on the display.</p> 		<p>Press the "+" key to turn on the module.</p>  <p>Turning on the  icon confirms the correct execution of the command.</p>
<p>To bring the Wi-Fi module back into Access Point mode and ready to connect to a Wi-Fi network, press the "F" key until the word WiFi appears on the display.</p> 		<p>Press the "+" key for 3" to reset the module.</p>  <p>The display of the word "AP" confirms the restoration of the Access Point mode.</p>





Wi-Fi module status is shown on the display by a small icon on the right side.

<p>Wi-Fi ON and CONNECTED TO A VALID NETWORK</p>	<p>symbol light steady</p>	
<p>Wi-Fi ON but NOT CONNECTED TO A NETWORK or CONNECTED TO A NETWORK WITHOUT INTERNET</p>	<p>symbol flashing</p>	
<p>Wi-Fi ON and ready for the initial configuration</p>	<p>symbol flashing</p>	
<p>Wi-Fi OFF</p>	<p>symbol not visible</p>	

Note: After switching on the product, the connection to the Wi-Fi network and the App requires a 30" waiting time at least. If the operation is not successful, the Wi-Fi symbol flashes and the App shows the product as disconnected. In this case it is necessary to switch off the radiator for at least 30 seconds before trying again.

See paragraph 7 for troubleshooting of the most common problems and the explanation of the error codes.

6.4 Utilities

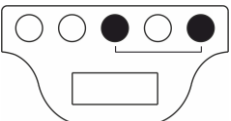
<p>Lock controls</p> <p>The radiator's controls can be locked to prevent settings being changed accidentally, or by unauthorised people. To go to lock/unlock mode, hold the "F" key down.</p> 		<p>Once the display reads "LOC":</p> <p>Hold the "F" key down and push the "+" key to lock the controls.</p>  <p>Activation is indicated by the relevant icon that switches on, on the display </p> <p>Hold the "F" key down and push the "-" key to unlock the controls.</p> 
<p>When this function is activated, in case the supply voltage returns after an interruption exceeding 30min, the operating mode set at the time of the interruption is recovered. If the operating mode was set to program P1 the frost free program is activated instead, because it is necessary to set the time and the day of the week before activating again a program.</p>		

7. Troubleshooting

Problem	Solution
The radiator does not switch on.	Check that the power supply is on and that it is as indicated in the radiator's nameplate (e.g. 230 Vac 50 Hz), and that the main switch on the right side of the radiator is switched on (position "I").
The radiator does not heat up.	Make sure that the operating mode is as required and, if using a preset programme, that you are not in a time period for which anti-freeze mode is set. If the ambient temperature is higher than that set, the radiator should not heat up. If in doubt, set Comfort mode and a required temperature much higher than the ambient temperature, to check that the radiator is working properly.
The radiator stays hot.	Check that the temperature setting is not too high or that there are no draughts on the radiator, altering the ambient temperature measured.
The radiator does not heat up enough.	Check that the temperature setting is not too low, that the radiator is only heating the room in which it is installed (keep the doors closed) and that the mains power supply is correct.
The radiator heats in Eco mode.	The radiator may heat up to reach / maintain the eco temperature. This is not abnormal operation.
The radiator's surface is very hot.	It is normal for the surface to be hot when working. The maximum values comply with the limits laid down by applicable safety norms. If the radiator is always very hot, it may be undersized for the space in which it is used, or may be affected by draughts.

<p>The temperature in the room differs from the temperature set.</p>	<p>Having waited for the ambient temperature to stabilise for at least 4 hours, you may have to compensate for any differences between the temperature indicated by the radiator and that measured in the room. To do this see the contents of paragraph 6.3 on the section "Aligning the outside temperature".</p>
<p>The radiator gives off an unpleasant odour.</p>	<p>When the radiator is new, it is possible that when it begins working for the first time an unpleasant odour may be sensed. This is due to residue from the manufacturing process. Radiators that have already been used may give off unpleasant odours if they are not used for a long time and/or if they are used in polluted spaces with poor quality air.</p>
<p>Unable to view the Wi-Fi network generated by the product.</p>	<p>Position yourself with your smartphone at a distance of no more than 3m from the product. The Wi-Fi network generated by the product is displayed in the smartphone's Wi-Fi settings and not in the App.</p>
<p>Unable to connect to the Wi-Fi network generated by the product to start the App configuration process.</p>	<p>If you have more than one product it is recommended to turn on and configure only one product at a time, not to get confused by the different Wi-Fi networks generated. Make sure you have correctly entered the network password Password123</p>
<p>The mobile device connects to the Wi-Fi network created by the product but the App shows a message indicating that no product has been found.</p>	<p>Do not move away from the product while connecting and turn off any other Wi-Fi network the smartphone may automatically connect to (excluding the one you want to connect the product to). Check on the display of the product that the Wi-Fi module is active, checking that  icon is lit and flashing. If not, follow the instructions to bring back the product to Access Point mode and try again. If the product Wi-Fi is correctly active, close the App, reopen it and then add the new product as first operation.</p>
<p>The App does not display any Wi-Fi network to connect the product to.</p>	<p>Make sure that the Wi-Fi network you want to connect the product to is switched on and that the signal arrives in the area where the product is installed. Check the intensity of the signal in the area where the product is installed. Signals that are too low or vary in intensity can create communication problems. In this case, you need to move the product to a new location or enhance the signal of the Wi-Fi network you must connect to.</p>
<p>After selecting the Wi-Fi network you want to connect the product to, you receive the message "<i>The product can not connect to the network</i>"</p>	<p>Verify you have entered the correct network password. Verify that the Wi-Fi network you want to connect the product to has an active internet connection. Press the Retry button until the procedure is successful. If after several attempts the procedure is not successful, bring the product back to Access Point mode and switch it off for 1 minute. Then repeat the procedure from the beginning.</p>

If any problem with the Wi-Fi module occurs, the product display shows an error code to help you to solve the problem:

Error	Description	Problem resolution
E01	The product cannot connect to the Wi-Fi network. The password entered to connect to the desired Wi-Fi network (not the one generated by the product) is incorrect or the network is no longer available or has changed its name.	Repeat the registration procedure by connecting to the Wi-Fi network generated by the product and wait for the App to show again the networks you can connect to. Select the desired one and re-enter the correct password.
E02	No Internet connection.	Restore Internet connection.
E03	Radialight server not reachable.	<p>Server maintenance may be in progress. It usually doesn't last longer than a few hours. Wait and verify the error is no longer shown and the Wi-Fi icon has stopped blinking.</p> <p>Whether the problem persists, remove the radiator from the App, restore the product Wi-Fi in Access Point mode and repeat the entire registration procedure as if the product were new.</p> <p>If the error comes out after successfully completing the registration it means that the Wi-Fi signal received by the radiator is too weak or variable and it is not possible to reset the connection. In this case move the radiator to another position or amplify the Wi-Fi signal.</p>
E04	Failed to register the product on the Radialight server.	The product is automatically reset in Access Point mode to be able to repeat the entire registration procedure from the beginning.
E05	Wi-Fi module disconnected.	Turn off the product with the main switch for 1min and then turn it on again. Whether the problem persists, try turning it off for at least 1 hour to clear the internal temporary memory and then switch it on again.
E06	Wi-Fi module error.	

8. Maintenance

- This product does not require any special maintenance.
- Clean the product, especially the heating panel, with a dry cloth once every 6 months.
- If the product requires repairing, contact an authorised technical service centre.
- When replacing the power cable, use a 2x1,00mm² or 3x1,00mm² H05V2V2-F HAR type, depending on the version. This operation, for cables both with and without plugs, must be performed by qualified personnel and never by the end user in order to avoid damaging the appliance and jeopardising personal safety.

9. Legal notice



Environment and recycling

Please help us to protect the environment by disposing of the packaging in accordance with the national regulations for waste processing.

Recycling of obsolete appliances

Appliances with this label must not be disposed off with the general waste. They must be collected separately and disposed off according to local regulations.

EN - Information requirements for electric local space heaters

Model identifier(s): KLIMA Wi-Fi					
Item	Symbol	Value	Unit	Item	Unit
Heat output				Type of heat input, for electric storage local space heaters only (select one)	
Nominal heat output	P_{nom}	(*) see Table 1	kW	manual heat charge control, with integrated thermostat	no
Minimum heat output (indicative)	P_{min}	(*) see Table 1	kW	manual heat charge control with room and/or outdoor temperature feedback	no
Maximum continuous heat output	$P_{max,c}$	(*) see Table 1	kW	electronic heat charge control with room and/or outdoor temperature feedback	no
Auxiliary electricity consumption				fan assisted heat output	no
At nominal heat output	e_{lmax}	0,000	kW	Type of heat output/room temperature control (select one)	
At minimum heat output	e_{lmin}	0,000	kW	single stage heat output and no room temperature control	no
In standby mode	e_{lsb}	0,00049	kW	Two or more manual stages, no room temperature control	no
				with mechanic thermostat room temperature control	no
				with electronic room temperature control	no
				electronic room temperature control plus day timer	no
				electronic room temperature control plus week timer	yes
				Other control options (multiple selections possible)	
				room temperature control, with presence detection	yes
				room temperature control, with open window detection	yes
				with distance control option	no
				with adaptive start control	no
				with working time limitation	no
				with black bulb sensor	no
Contact details	Ermete Giudici S.p.A. - via L. da Vinci 27 - 20090 Segrate (MI) Italia				

Table 1		KLIMA 7 Wi-Fi KLIMA 7 AS Wi-Fi	KLIMA 10 Wi-Fi	KLIMA 15 Wi-Fi	KLIMA 20 Wi-Fi
Heat output					
Nominal heat output	P_{nom}	0,750	1,000	1,500	2,000
Minimum heat output (indicative)	P_{min}	0,075	0,113	0,150	0,188
Maximum continuous heat output	$P_{max,c}$	0,750	1,000	1,500	2,000

SLOVENSKO

NAVODILA ZA UPORABO

Preden začnete upravljati z napravo, skrbno preberite navodila v izogib škodi in nevarnim situacijam. Vsaka raba izdelka, ki ni v skladu s priloženimi navodili, lahko povzroči požar, električni udar ali poškodbe in izniči garancijo.

Garancija se ne nanaša na okvare, izgube, poškodbe ali škodo, ki je posledica nepravilne rabe izdelka. Garancija ne vpliva na pravice določene v državni zakonodaji. Pogoji te garancije ne izključujejo pogojev za garancijo, kot so določeni v državni zakonodaji in ki jih ni mogoče opustiti ali spreminjati.

Preden izdelek začnete uporabljati, odstranite embalažo in preverite stanje izdelka. V primeru okvar ali poškodb ne poskušajte izdelka popraviti sami, temveč stopite v stik z distributerjem.

Ne pustite otrokom, da se igrajo z embalažo. Zavarujte okolje in odvrzite embalažo v skladu z uredbami o varovanju okolja.

1. Za vašo varnost

- ❑ Ta izdelek je namenjen uporabi v gospodinjstvu in ne za komercialno/industrijsko rabo, v vozilih, na plovilih in letalih.
- ❑ To napravo lahko uporabljajo otroci stari 8 let in več ter osebe z zmanjšanimi fizičnimi, senzoričnimi in mentalnimi sposobnostmi ali manj izkušene osebe, a le pod nadzorom ali če so poučeni o varni rabi izdelka in razumejo tveganja povezana z rabo izdelka.
- ❑ Otroci se z napravo ne smejo igrati. Otroci ne smejo čistiti in vzdrževati naprave brez nadzora.
- ❑ Otroci mlajši od treh let naj se napravi izogibajo, razen če so pod stalnim nadzorom.
- ❑ Otroci od treh do osmih let lahko prižigajo/ugašajo napravo le, če je ta nameščena pravilno in le pod nadzorom ali če so poučeni o varni rabi naprave in razumejo tveganja povezana z rabo izdelka.
- ❑ Otrokom od treh do osmih let ni dovoljeno vklapljanje, reguliranje, čiščenje in vzdrževanje naprave.
- ❑ **OPOZORILO — Nekateri deli te naprave lahko postanejo zelo vroči in lahko povzročijo opekline. V prisotnosti otrok in ranljivih oseb je potrebna posebna pozornost.**
- ❑ Poskrbite, da nazivna moč ustreza tisti, ki je navedena na nazivni ploščici: 230V~, 50Hz.
- ❑ Ne dovolite otrokom in živalim, da se dotikajo naprave ali igrajo z njo. Bodite pozorni! Rešetka za odvod zraka se med delovanjem ogreje (približno 80°C).
- ❑ **OPOZORILO: Ne pokrivajte konvektorja, da se izognete pregretju.**

Ne obešajte stvari na konvektor in ga ne pokrivajte med delovanjem.

To je jasno označeno na napravi s simbolom



- ❑ Naprave ne uporabljajte v sobah z eksplozivnim plinom ali medtem, ko uporabljate vnetljiva razredčila, lake ali lepila.
- ❑ Če je kabel poškodovan in je potrebna menjava, ne počnite tega sami! Napravo peljite na pooblaščen servis, da se izognete morebitni nevarnosti.
- ❑ Naprava naj bo nameščena tako, da je vtičnica vedno dostopna.
- ❑ Naprave nikoli ne nameščajte neposredno pod vtičnico.
- ❑ Ne vstavljajte predmetov ali papirjev v radiator.

2. Vaš izdelek

- ❑ Poleg grelca, ki ste ga izbrali, paket vsebuje (slika 1):
 - 1 konzola za namestitev na steno (pritrjena na radiator);
 - 4 vložki za vijake 8x50mm;
 - 4 križni vijaki za pritrnitev konzole 5x60mm;
- ❑ V primeru manjkajočih ali polomljenih delov se obrnite na vašega dobavitelja.

3. Varna namestitev

- ❑ Napravo uporabljajte le v horizontalnem položaju.
- ❑ Konvektor je opremljen z električnim vezjem s stopnjo zaščite dvojne izolacije (razred II) in zato ne potrebuje ozemljitve.
- ❑ Pri nameščanju vedno upoštevajte minimalno razdaljo od sten, pohištva in/ali predmetov, kot je to prikazano na sliki 2.
- ❑ Naprave nikoli ne nameščajte na lesene površine ali površine iz sintetičnih materialov.
- ❑ Ta naprava ima zaščito pred vodo IP24, zato jo lahko uporabljamo v kopalnicah in drugih vlažnih prostorih, pod pogojem, da nikoli ni nameščena v območje kadi ali tušev (slika 2, del 1).
- ❑ Naprave ne nameščajte na prepišno območje, ker bi to lahko zmotilo uravnavanje temperature.

4. Namestitev

- ❑ Odstranite konzolo za namestitev z zadnjega dela naprave; najprej sprostite zgornji dve vzmeti, nato pa še spodnji dve, kot je to prikazano na sliki 4.
- ❑ Konzolo odložite na tla in jo uporabite kot vodilo za oznako točk, kjer boste zvrtili spodnji dve luknji za pritrnitev (slika 5A).
- ❑ Konzolo dvignite, dokler se spodnji luknji za pritrnitev ne ujameta z oznakami, ki ste jih naredili na steno. S svinčnikom označite še položaj zgornjih dveh odprtin za pritrnitev (slika 5B).
- ❑ Na označenih mestih zvrtejate 4 luknje in vstavite priložene plastične vložke (slika 6).
- ❑ S priloženimi vijaki pritržite konzolo na steno (slika 7).
- ❑ Spodnja dva zatiča za pritrnitev na radiatorju nataknite na konzolo, nato pa še zgornja dva, da se zaskočita v svoj položaj (slika 8).
- ❑ V primeru, da bi morali kasneje kdaj odstraniti radiator s konzole, priporočamo, da najprej sprostite spodnja dva zatiča, šele nato zgornja.

5. Električna povezava

- ❑ Izdelek se napaja pri napetosti 230V AC 50Hz.
- ❑ Izdelek mora biti opremljen s kablom in vtičnem ali inštalacijskem kablom.
- ❑ V kopalnicah, kuhinjah in drugih vlažnih prostorih, mora biti povezava na električno energijo nameščena vsaj 25 cm nad tlemi.
- ❑ Priključek na električno omrežje mora biti opremljen tudi z dvopolnim stikalom z minimalnim razmakom med kontakti 3 mm. Vedno sledite zakonskim določilom in predpisom za elektroenergetske napeljave v vaši državi.
- ❑ Prepovedano je napravo povezati na ozemljitev. **NE POVEŽITE ČRNE ŽICE NA OZEMLJITEV.**
- ❑ Če se naprava napaja s 30mA diferencialnim stikalom, mora biti tudi pilotna črna žica povezana nanj.

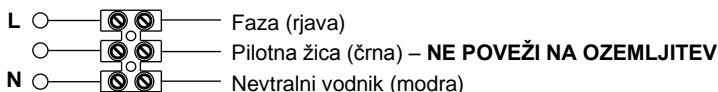

6. Raba naprave

6.1 Opis ukazov

- A – Vklp/Stanje pripravljenosti
- B – Način delovanja
- C – Posebne funkcije
- D – Povečaj/Vklopi
- E – Zmanjšaj/Izklopi
- F – Zaslon
- G – Glavno stikalo

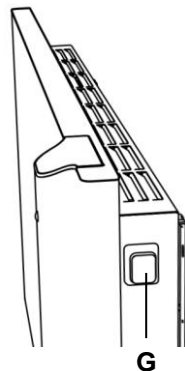
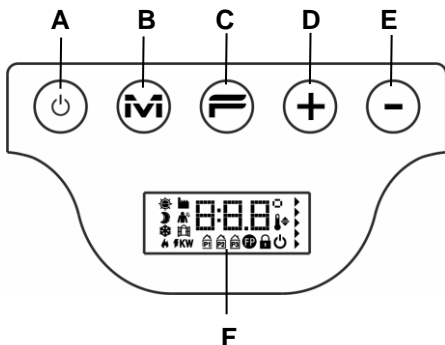

6.2 Delovanje

6.2.1 Prižiganje zaslona

<p>Če zaslon ni prižgan, pritisnite na katerokoli tipko, da se prižge. Zaslon se zasveti in ostane prižgan še 30 sekund po zadnjem pritisku tipke.</p>		<p>Pri ugasnjem zaslonu pritisek katerekoli tipke aktivira delovanje zaslona in ne njeno funkcijo.</p>
--	--	--



6.2.2 Vklp in izklp radiatorja

Naprava se vklopi z elektromehanskim stikalom za vklop/izklp (G), ki je na desni strani radiatorja. Stikalo za vklop/izklp prekine dotok električne energije napravi in po 30 minutah se vse prej vnesene shranjene nastavitve izbrišejo. Uporabo stikala priporočamo le, če je naprava ugasnjena dalj časa.

Pri krajših izklopih naprave priporočamo uporabo funkcije stanja pripravljenosti (Stand-by), ki ohrani vse prej vnesene nastavitve.

<p>Ko radiator vklopite z glavnim stikalom (G), se ekran zasveti in prikaže se znak za stanje pripravljenosti (Stand-by).</p>		
<p>Radiator prižgite s pritiskom tipke Stand-by.</p>		<p>Radiator se vedno prižge v način Comfort. Če je naprava nova ali je bila izklopljena več kot 30 minut, je vrednost temperature Comfort samodejno 19°C.</p>

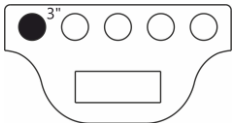
Radiator ugasnete s pritiskom na tipko Stand-by, držite vsaj 3 sekunde.

Če radiator izklopite s stranskim stikalom, bodo po 30 minutah izgubljeni vsi shranjeni podatki (dan, ura, nastavitve temperature, itd.).

6.2.3 Izbira načina delovanja





S pritiskanjem na tipko "M" izberete želeni način delovanja.





Z vsakim pritiskom na tipko "M" se način delovanja spreminja po sledečem zaporedju:



Po 30 minutah od zadnjega pritiska na tipko "M", se zaporedje znova prične na začetku, tako da lažje preklopimo iz kateregakoli načina delovanja v način Comfort.

Simbol	Opis	Kdaj izbrati določen način delovanja
	Comfort	Ko ste doma: Radiator vzdržuje izbrano temperaturo Comfort
	Eco	Ko vas krajši čas ni doma (od 2 do 48 ur) ali ko spite: Radiator vzdržuje nastavljeno Eco temperature in varčuje z energijo.
	Anti-freeze	Ko vas ni doma dalj časa (več kot 48 ur): Temperatura je samodejno nastavljena na 7±3°C in se je ne da spreminjati.
	Program P1	Prednastavljeni program za ljudi, ki ne delajo od doma. TA PROGRAM SE LAHKO TUDI POLJUBNO SPREMINJA S POMOČJO NAVODIL V POGLAVJU 6.2.6
	Pilot Wire	Samo za radiatorje s kablom brez vtičaka (Francija)

6.2.3.1 Opis prednastavljenih programov

	Ponedeljek-Petek Sobota-Nedelja	<table border="0"> <tr> <td>00:00</td><td>06:00</td><td>08:00</td><td>12:00</td><td>14:00</td><td>17:00</td><td>24:00</td> </tr> <tr> <td>□</td><td>□</td><td>□</td><td>■</td><td>□</td><td>□</td><td>□</td> </tr> <tr> <td>□</td><td>□</td><td>□</td><td>■</td><td>□</td><td>□</td><td>□</td> </tr> </table>	00:00	06:00	08:00	12:00	14:00	17:00	24:00	□	□	□	■	□	□	□	□	□	□	■	□	□	□
00:00	06:00	08:00	12:00	14:00	17:00	24:00																	
□	□	□	■	□	□	□																	
□	□	□	■	□	□	□																	
<p>■ = temperatura "COMFORT" □ = temperatura "ECO" * = temperatura Anti-freeze</p>																							

Program P1 se lahko spreminja (navodila v poglavju 6.2.6).

Za nastavitve temperatur (velja za vse programe):







- Izberite način Comfort in vnesite želeno temperaturo.
- Izberite način Eco in vnesite želeno temperaturo.
- Izberite želeni program P1.

Prosimo upoštevajte: Če izberete program P1, ne da bi predtem kdaj nastavili dan in uro, bo sistem samodejno odprl meni za nastavitve dneva in ure (poglavje 6.2.5)





6.2.3.2 Pilot wire



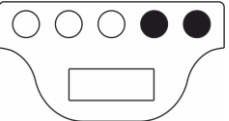

Samo za radiatorje s kablom brez vtičaka, na voljo le v Franciji.

6.2.4 Nastavitev temperatur

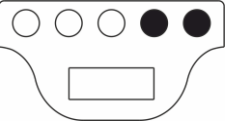
<p>Radiator ima dve referenčni temperature, Comfort in Eco. Vsako lahko določimo posebej.</p>		<p>Na desni strani zaslona je lestvica, ki z barvo od zelene do rdeče nakazuje, kako močno se temperatura razlikuje od priporočenih 19°C</p>
<p>Prednastavljena temperatura Comfort je 19,0°C in jo lahko spreminjamo s tipkama "+" in "-".</p> 		<p>Če je temperatura Comfort nastavljena nižje kot temperatura Eco, se slednja samodejno nastavi na temperaturo Comfort - 0,5°C.</p>
<p>Prednastavljena temperatura Eco je 15,5°C in jo lahko spreminjamo s tipkama "+" in "-".</p> 		<p>Priporočena razlika med temperaturo Comfort in Eco je 3,5°C. Če je razlika drugačna od predlagane, se Eco simbol spremeni, kot je prikazano spodaj:</p>  <p>Največja vrednost Eco temperature je lahko enaka temperaturi Comfort - 0,5°C.</p>
<p>Če je temperatura prostora nižja, kot je zelena temperatura in izpisana temperatura, se na zaslonu prikaže simbol za ogrevanje .</p>		

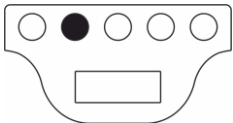
6.2.5 Nastavitev dneva in ure

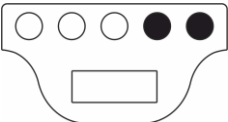
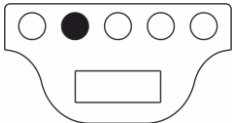
<p>Dan in uro je treba nastaviti zato, da lahko uporabljamo 3 prednastavljene programe.</p> 		<p>Na zaslonu se prikaže meni za nastavev dneva (1 = ponedeljek). Pravi dan izberemo s tipkama "+" ali "-".</p> 
<p>Ko s tipko "M" potrdite nastavev dneva, lahko nastavite uro.</p> 		<p>Na zaslonu se prikaže meni za nastavev ure. Uro izberemo s tipkama "+" ali "-".</p> 

<p>Ko s tipko "M" potrdite nastavev ure, lahko nastavite minute.</p> 		<p>Na zaslonu se prikaže meni za nastavev minut. Minute nastavimo s tipkama "+" ali "-".</p> 
<p>S pritiskom na tipko "M" zaključite nastavev dneva in ure.</p> 		<p>Sistem se bo povrnil nazaj v zadnji izbrani način delovanja.</p> <p>Če izberete prednastavljeni program, ne da bi predtem kdaj nastavili dan in uro, bo sistem samodejno odprl meni za nastavev dneva in ure.</p>

6.2.6 Prilaganje Programa P1









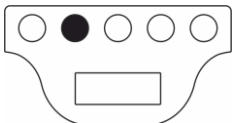

Uporabnik lahko program P1 spreminja glede na svoje potrebe.

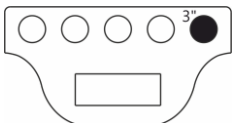

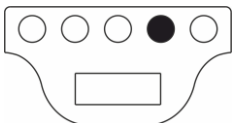

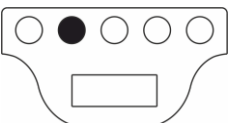

Prilaganje programa daje uporabniku možnost, da si sam izbere zeleno temperaturo prostora in način delovanja Comfort, ECO ali Frost Free in to za vsako uro ter vsak dan v tednu.

Za vnos temperatur za vsak način delovanja glejte poglavje 6.2.4.

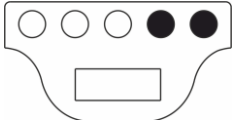
Vsaka prikazana ura prikazuje trenutno nastavljenno temperaturo programa P1. Pri prvi uporabi radiatorja je profil programa P1 enak opisanemu v poglavju 6.2.3.1.

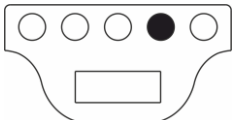

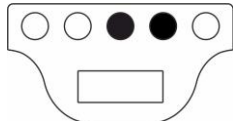
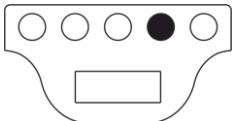

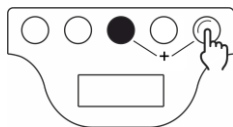





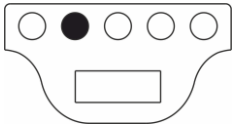

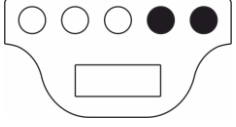
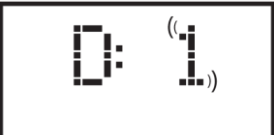
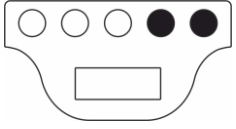

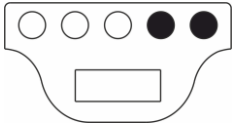
Za prikaz in spreminjanje programa P1, je postopek sledeč:

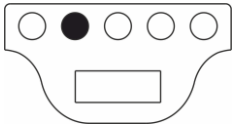

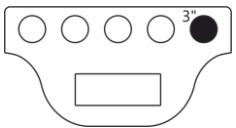

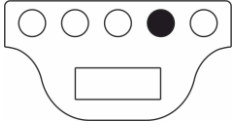

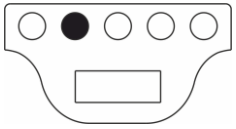

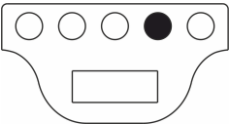

<p>S tipko "M" izberite program P1.</p> 		<p>V primeru, da dan in ura prej nista bila nastavljena (naprava je nova ali je bila izklopljena več kot 30 minut), se samodejno odpre meni za nastavev dneva in ure (gl. Poglavje 6.2.5).</p>
<p>Za prikaz programa P1 držite tipko "-" 3 sekunde.</p> 		<p>Na zaslonu se prikaže prvi dan za vnos/ogled nastavev (1= ponedeljek)</p>
<p>S pritiskom na tipko "+" se prikaže prva ura za vnos/ogled nastavev.</p> 		<p>S pritiskom na tipko "M" izberite zeleno temperaturo Comfort, Eco ali Frost Free:</p>  <p style="text-align: center;">  →  →  </p> <p>Temperatura, ki se prikaže na zaslonu, potem ko izberete določeno dnevno uro, je tista, ki je trenutno nastavljena v programu P1.</p>

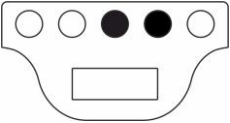
<p>S tipkama "+" in "-" še ostale ure prvega dneva in si za vsako od njih oglejte/spremenite delovno temperaturo.</p> 		<p>Ura, ki je prikazana vedno nakazuje začetno točko, npr.: Ko je na zaslonu H 23, vnos temperature zajema obdobje med 23:00 in 00:00.</p>
<p>Po tem, ko ste vnesli temperature za vsako uro prvega dne, s ponovnim pritiskom na tipko "+" lahko vnesete spremembe za dan 2.</p> 		<p>S pritiskom na tipko "+" si oglejte/spremenite delovno temperaturo za vse ure drugega dne, tako kot ste to naredili za dan 1. Če držite tipko "F" in pritisnete tipko "-" lahko za dan 2 samodejno nastavite isti program kot za dan 1.</p>  <p>Opomba: Isti dnevni program lahko kopirate in lepote LE, KO je prikazana številka dneva, ki ga želite prilagoditi (kot kaže slika), A NE, ko je na zaslonu prikazana ura.</p>
<p>Ko ste nastavili še zadnji dan (dan 7), pritisnete tipko in tako zaprete način pregrevanja.</p> 		<p>Na zaslonu se bo prikazala beseda END. Z nadaljnjim pritiskom na tipko "+" potrdite vnos podatkov v program.</p>
<p>Znak OK se pojavi na zaslonu za 5 sekund in tako potrdi, da je bil vnos podatkov v program uspešen. Sistem je sedaj nastavljen tako, da spreminja temperaturo glede na nove vnose v program P1.</p>		<p>Opomba: Iz menija za nastavev programa lahko izstopite kadarkoli brez prikazovanja vseh dnevnih ur do dneva 7.</p> <p>To naredite z držanjem tipke "F" in pritiskom tipke "-".</p> 
<p>Pomnite:</p> <ul style="list-style-type: none"> - Prikaz/spreminjanje tedenskega zaporedja lahko s tipko Stand-by prekinete kadarkoli in s tem izbršete vse neshranjene nastavitve; - Ponastavitev tovarniških nastavitvev izbršite podatke predhodno vnesenega programa P1 (gl.6.3); - Če med nastavljanjem programa 90 sekund ne pritisnete na nobeno tipko, se ta postopek prekine, ponovno se vzpostavijo tovarniške rešitve; - Med nastavljanjem programa, so grelni elementi v stanju pripravljenosti in radiator ne greje. 		

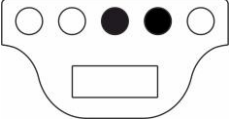

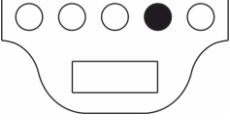

PRIMER: KAKO NASTAVIMO PROGRAM PO MERI





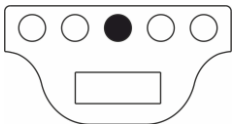

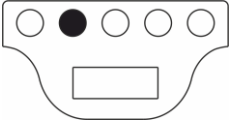

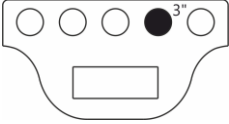

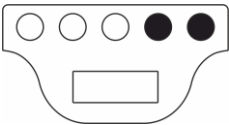
Poglejmo, kako nastaviti program pri novem radiatorju s prehodom iz načina ECO v način COMFORT eno uro prej (ob 6:00 v tovarniških nastavitvah) za vsak dan od ponedeljka do petka:

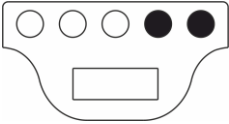

<p>Pritisnite tipko "M" za izbor programa P1.</p>		
<p>S tipkama "+" in "-" določite tekoči dan v tednu (prva raba radiatorja).</p>		
<p>Pritisnite tipko "M" in pričnite z vnosom časa (prva raba radiatorja). S tipkama "+" ali "-" izberite uro.</p>		
<p>Pritisnite tipko "M" in vnesite še minute (prva raba radiatorja). S tipkama "+" ali "-" vnesite minute.</p>		
<p>S pritiskom na tipko "M" zaključite vnos časovnih nastavitvev. Sistem bo zdaj prešel nazaj na program P1.</p>		
<p>Držite tipko "-" vsaj 3 sekunde in pričnite z vnosom/prikazom nastavitvev za dan 1.</p>		
<p>Pritiskajte tipko "+", dokler se na zaslonu ne prikaže H:05 (to je ura, pri kateri želimo spremeniti temperaturo ECO v COMFORT).</p>		
<p>Dvakrat pritisnite na tipko "M" in tako spremenite raven temperature iz ECO v COMFORT.</p>		

<p>Pritisnite tipko "+", dokler se na zaslonu ne prikaže D:2 (torek).</p>		
<p>Za kopiranje programa dneva 1 na dan 2 držite tipko "F" in pritisnite tipko "+". Sistem bo samodejno kopiral program in preskočil na dan 3 (sreda).</p>		
<p>Zgoraj opisani postopek ponavljajte, dokler se na zaslonu ne prikaže D: 6.</p>		
<p>Ker dneva 6 in 7 ne želimo spreminjati, lahko z držanjem tipke "F" in pritiskom tipke "-" zapremo meni za programske nastavitve. Na zaslonu se prikaže "END".</p>		
<p>S pritiskom na tipko "+" potrdimo vnesene spremembe. Na zaslonu bo 5 sekund utripal znak "OK".</p>		

6.3 Posebne funkcije

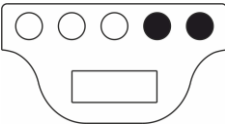

<p>S pritiskanjem na tipko "F" lahko izbirate med različnimi posebnimi funkcijami.</p> 		<p>Za izhod iz menija za posebne funkcije pritisnite tipko "M" ali pa samo počakajte 12 sekund, da se meni zapre sam.</p> 
<p>Ponastavitev na tovarniške nastavitve</p> <p>Opomba: Obnovitev tovarniških nastavitve NE bo izbrisala nobenih predhodno shranjenih nastavitve Wi-Fi povezave.</p>		<p>Za ponastavitev vseh parametrov na tovarniške nastavitve držite tipko "+" vsaj 3 sekunde.</p> 

<p>Modul Wi-Fi</p> <p>S pomočjo te funkcije lahko povežete vaš radiator z Wi-Fi omrežjem in ga upravljate preko aplikacije.</p> <p>Za več informacij glej poglavje 6.3.3.</p>		<p>To funkcijo vklopite s pritiskom na tipko "+" in izklopite s pritiskom na tipko "-".</p>  <p>Ko je funkcija vklopljena, se na zaslonu prikaže ikona .</p>
<p>Senzor za zaznavanje prisotnosti</p> <p>S pomočjo tega senzorja radiator sam zazna, ali so v prostoru prisotni ljudje ali ne, in samodejno uravna raven gretja za kar največje udobje in prihranek energije.</p> <p>Za več informacij glej poglavje 6.3.1.</p>		<p>Funkcijo vklopimo ali izklopimo s pritiskom na tipko "+" (ON) ali "-" (OFF).</p>  <p>Ko je funkcija vklopljena, se na zaslonu prikaže ikona .</p>
<p>Senzor za zaznavanje odprtega okna</p> <p>Ta funkcija zazna, ali je v prostoru odprto okno in samodejno vklopi način delovanja Anti-freeze.</p> <p>Za več informacij glej poglavje 6.3.2.</p>		<p>Funkcijo vklopimo ali izklopimo s pritiskom na tipko "+" (ON) ali "-" (OFF).</p>  <p>Ko je funkcija vklopljena, se na zaslonu prikaže ikona .</p>
<p>Dnevna poraba</p> <p>S to funkcijo lahko preverite, koliko energije je radiator porabil za delovanje v zadnjih 24 urah.</p>		<p>Če simbol za dnevno porabo utripa, to pomeni, da podatki o porabi zajemajo obdobje krajše od 24 ur.</p> <p>Upoštevanje: Na zaslonu je prikazana le ocena porabe, ta se lahko razlikuje od vrednosti, ki jo izmerijo za to namenjene naprave.</p>
<p>Tedenska poraba</p> <p>S to funkcijo lahko preverite, koliko energije je radiator porabil za delovanje v zadnjih 7 dnevih.</p>		<p>Če simbol za dnevno porabo utripa, to pomeni, da podatki o porabi zajemajo obdobje krajše od 7 dni.</p> <p>Upoštevanje: Na zaslonu je prikazana le ocena porabe; ta se lahko razlikuje od vrednosti, ki jo izmerijo za to namenjene naprave.</p>
<p>Prikaz temperature v prostoru</p>		<p>Na zaslonu se prikaže temperatura prostora, ki jo meri radiator.</p>

<p>Usklajevanje temperature v prostoru</p> <p>S to funkcijo uravnamo temperaturo v prostoru, ki jo meri radiator in moč greja, če jo je treba popraviti, npr. zaradi bližine drugih virov toplote ali prepiha.</p>		<p>Na zaslonu se prikaže vrednost, za katero je treba uravnati temperaturo. To naredimo s pritiskom na tipko "+" ali "-".</p>  <p>Če je na primer temperatura, pri kateri greje radiator, 19,2°C, temperatura v prostoru pa meri 19,5°C, jo uravnajte za +0,3°C.</p> <p> Preden uravnate temperaturo, počakajte vsaj 4 ure, da se temperatura v prostoru ustali.</p>
---	---	---

6.3.1 Senzor za zaznavanje prisotnosti

S pomočjo tega senzorja radiator sam zazna, ali so v prostoru prisotni ljudje ali ne, in samodejno uravna raven gretja za kar največje udobje in prihranek energije. S to funkcijo, ki jo lahko vklopimo le pri načinu delovanja Comfort, radiator stalno spremlja prostor in če v njem ne zazna prisotnosti ljudi, zmanjša nastavljeno temperaturo:

Čas odsotnosti	Zmanjšanje temperature Comfort	Prikaz na zaslonu
60 min	1,0°C	Ikona za način delovanja Comfort in ikona za senzor za zaznavanje prisotnosti zasvetita hkrati.   (())
90 min	2,0°C	
120 min	3,5°C	
38 ur	Vklop Anti-freeze 7±3°C	

Zmanjšanje temperature je vedno vezano na vrednost temperature Comfort. Če imamo vklopljen način delovanja Eco ali Anti-freeze, radiator ne bo zmanjševal temperature.

Če senzor zazna prisotnost osebe v sobi za vsaj 10 zaporednih minut, se temperatura samodejno vrne nazaj na nastavljeno temperaturo Comfort. Enako tudi, če pritisnemo tipko "M" med samim nižanjem temperature zaradi odsotnosti oseb iz prostora.

Pomembno:

Za pravilno delovanje te funkcije je pomembno, kje v prostoru je radiator nameščen. Pri izbiri mesta namestitve upoštevajte, da senzor zaznava gibanje znotraj območja, ki je prikazan na sliki 9 in da pred senzorjem ne sme biti nobenih predmetov. Zaznavanje prisotnosti je bolj učinkovito, če se osebe premikajo pred senzorjem, kot pa če se premikajo proti senzorju.

6.3.2 Zaznavanje odprtega okna

S pomočjo te funkcije radiator zazna, če je v prostoru odprto okno in samodejno vklopi način Anti-freeze.

Če senzor med ogrevanjem zazna nenaden padec temperature v prostoru, se samodejno vklopi način Antifreeze in tako prepreči potratu energije. Na zaslonu se hkrati prikažeta znak za odprto okno in za način Anti-freeze, prikazan je tudi izbrani način delovanja.

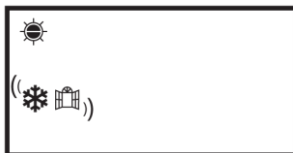

Povratak v normalno delovanje ni samodejen in ga aktivirate s pritiskom na tipko "M".





Pomembno:

Na pravilno delovanje te funkcije lahko vpliva mesto naprave v sobi, morebiten prepih, zunanja temperatura ali koliko časa je bilo okno odprto.

6.3.3 Uporaba aplikacije

S pomočjo te funkcije lahko povežete vaš radiator z Wi-Fi omrežjem, ki ima dostop do interneta, in ga upravljate preko aplikacije Radialight®.

Za povezavo naprave na omrežje WiFi sledite navodilom v aplikaciji ali podrobnemu vodiču s slikovnim prikazom.

	android	Apple iOS
PRENESITE APLIKACIJO	 www.radialight.com/app-android	 www.radialight.com/app-ios
ODPRITE HITRI VODIČ	 www.radialight.com/android-start-guide	 www.radialight.com/ios-start-guide

Ko zaključite s postopkom povezave, se v aplikaciji prikaže ta naslovna stran:

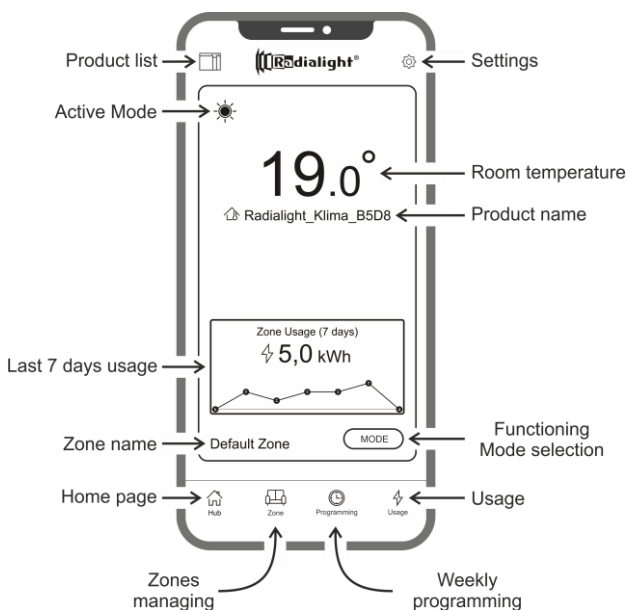

Seznam naprav (Product list):

Omogoča pregled registriranih naprav in dodajanje novih. Trenutno izbrani način delovanja, ime območja gretja in ikona gretja so prikazani za vsako napravo posebej.

Aplikacija vam omogoča spreminjanje dodeljenega območja gretja, ime naprave in vklop/izklop naprave.

Če ikono za posamezno napravo povlečete iz desne na levo, se bo prikazal gumb, s katerim napravo lahko izbrisete s seznama vseh naprav.

Izbrani način delovanja (Active Mode):

Trenutno izbrani način delovanja je prikazan z isto ikono, kot na ekranu naprave.

Če je izbran prednastavljeni program, se zraven ikone načina delovanja prikaže še ikona za uro. Desno od simbola je izpisano tudi ime programa.

Poraba v zadnjih 7 dneh:

Prikaže se poraba energije v zadnjih 7 dneh. Ta je prikazana tudi grafično za vsak dan posebej. S pritiskom na graf dostopate do analize porabe.

Ime območja gretja (Zone name):

Prikaže ime, ki ste ga izbrali za določeno območje gretja.

Upravljanje območij gretja (Zone management):

Omogoča pregled določenih območij, brisanje in dodajanje novih. Pri vsakem območju gretja sta izpisana tudi ime in izbrani način delovanja, možno je tudi spreminjanje nastavitev vseh naprav v določenem območju gretja.

Tedensko programiranje (Weekly programming):

S pritiskom na to ikono dostopate do funkcije tedenskega programiranja. Lahko spreminjate prednastavljene programe ali dodajate nove. Vsakemu programu lahko dodate ime in barvo.

Program lahko tudi izklopite, če ikono za tedensko programiranje povlečete iz desne proti levi.

Poraba (Usage):

S to ikono dostopamo do analize porabe in pregledujemo zbrane podatke o dnevni, tedenski ali mesečni porabi.

Izbira načina delovanja (Operating Mode selection):

Tu lahko izberete način delovanja radiatorja (Comfort, Eco, Antifreeze, Programmed, Pilot wire ali stanje pripravljenosti Stand-by). Po želji lahko določite, koliko časa naj radiator deluje v enem načinu delovanja, preden se vrne nazaj na predhodno izbrani način delovanja.

Ime naprave (Product Name):

Na sredi zaslona je izpisano ime naprave. Če je v enem območju gretja registriranih več naprav, je izpisano ime območja gretja in temperatura.

Temperatura prostora (Room temperature):

Izpisana je temperatura v prostoru, ki jo meri senzor v vaši napravi.

Nastavitve (Settings):

Tu lahko:

- Pogledate vodič po delovanju aplikacije
- Vključite nadzor nad stroški porabe, tako da poleg kWh vnesete tudi ceno enote energije
- Upravljate možnosti obveščanja o vklopu/izklopu senzorja za odprto okno
- Upravljate možnosti obveščanja o vklopu stanja pripravljenosti pri napravah
- Upravljate možnosti obveščanja o preseganju porabe ali stroškov
- Spreminjate geslo uporabniškega računa
- Spreminjate soglasje o prejemanju posodobitev in promocijskih obvestil

S pritiskom na območje gretja si lahko ogledate podrobne nastavitve:

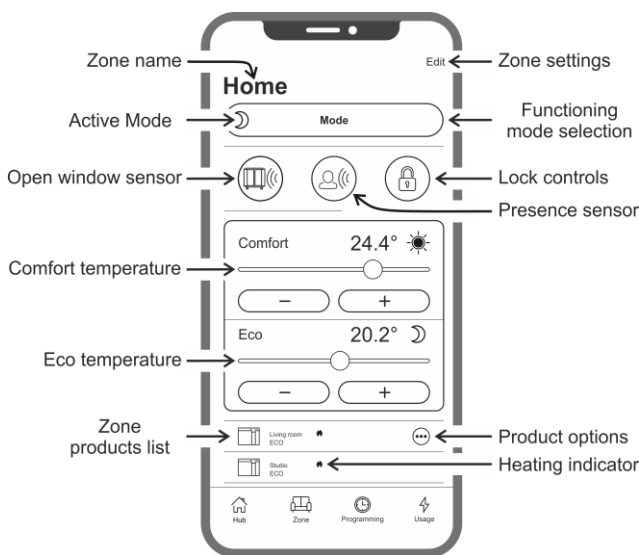

Senzor za zaznavanje odprtega okna: (Open window sensor)

Tu vklopite/izklopite senzor za zaznavanje odprtega okna (g. poglavje 6.3.2).

Senzor za zaznavanje prisotnosti (Presence sensor):

Vključite/izklopite možnost samodejnega zmanjšanja temperature Comfort, ko je prostor prazen določen čas (glej 6.3.1).

Zaklepanje tipkovnice (Lock controls):

Omogoča zaklep tipk na napravi in tako onemogoči spreminjanje prej vnesenih nastavitvev (gl. 6.4).

Seznam naprav v območju gretja (Zone products list):

Na seznamu so vse naprave, ki spadajo v določeno območje gretja. Pri vsaki napravi je izpisano njeno ime in izbran način delovanja.

Indikator gretja (Heating indicator):

Ta ikona se prikaže, kadar je temperatura v prostoru nižja od zelene in naprava deluje, da prostor ogreje.

Možnosti naprave (Product options):

Tu napravi lahko določite območje greinja in ime ali pa jo izklopite.

Nastavitve območja greinja (Zone settings):

Tu lahko spremenite ime območja greinja in sliko za ozadje.

Neskladnost:

Če sta v enem območju greinja dve ali več naprav in ima ena ali več izmed teh naprav drugačne nastavitve, kot so sicer določene za to območje greinja, pride do neskladja.

To neskladje je navadno posledica ročnih sprememb parametrov radiatorja in lahko vpliva na način delovanja radiatorja ali moteno zaznavanje temperature Comfort ali Eco.

V tem primeru aplikacija nakaže na neskladnost tako, da se prikaže simbol, ki ga vidite na sliki na desni strani.

Ta simbol se lahko prikaže tudi v zgornjem levem kotu ikone za območje greinja na dnu zaslona. Tako uporabnik vidi, da ima ena izmed naprav nastavitve, ki niso v skladu z nastavitvami določenimi za isto območje greinja.

S pritiskom na ta simbol lahko ponastavite vse naprave na nastavitve, ki so bile predhodno določene za določeno območje greinja.

Če ste nastavitve na napravah namenoma spremenili, lahko te simbole spregledate.

Če pa večkrat uporabljate različne nastavitve na napravah, je bolj smiselno, da naprave dodelite v različna območja greinja in jih na ta način upravljate, ne da bi se vam pri tem prikazovali simboli za neskladnost.

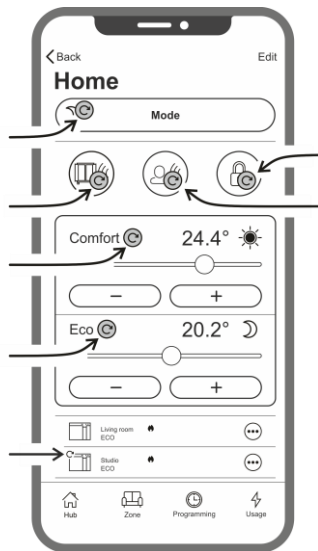

Dobro je vedeti:

Upravljanje časovnih nastavitvev:

Trenutni čas in dan tedna se preneseta na radiator ob prvi registraciji naprave. Hkrati se shrani tudi časovni pas območja, kjer se naprava nahaja.

Prehod ure iz zimskega na letni čas in obratno ni samodejen. Če se želite prepričati, ali so naprave nastavljene na pravi čas, potem ko ste vnesli spremembo časa, je dovolj da pošljete kakršenkoli ukaz v eno izmed območij ogrevanja.

Izpad energije

Če je dotok energije prekinjen za več kot 30 minut, se izbriše mnogo nastavitvev radiatorja. Ob povratku električne energije, se naprava samodejno poveže na omrežje Wi-Fi, vklopi pa se način stanja pripravljenosti (Stand-by).

Priporočamo vam, da preverite, ali se nastavitve naprav skladajo z nastavitvami, kot so določene v aplikaciji.

V nastavitvah aplikacije lahko vklopite tudi sporočila za obveščanje in tako vidite, ali je katera izmed naprav v stanju pripravljenosti, čeprav so nastavitve območja greinja drugačne.

Obvestila









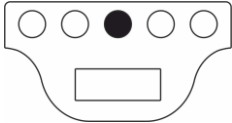

V nastavitvah aplikacije lahko določite, katera obvestila želite prejemati. Obvestila se prikažejo, ko je aplikacija zaprta ali odprta, če ste to možnost omogočili med samo namestitvijo aplikacije.

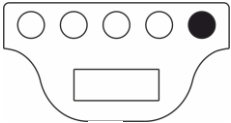
Moč Wi-Fi signala

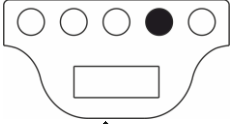

Če je radiator nameščen v območju, kjer Wi-Fi signal ni močan, je lahko izvajanje ukazov, ki jih pošiljate preko aplikacije, počasnejše, lahko pa pride tudi do prekinjene komunikacije. Temu se izognete tako, da pojačate moč Wi-Fi signala v prostoru, kjer je radiator nameščen.

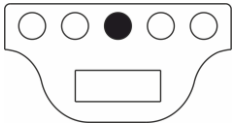
Upravljanje Wi-Fi modula:

Wi-Fi modul lahko vklopite ali izklopite:

<p>Wi-Fi modul izklopite s pritiskom na tipko "F", dokler se na ekranu ne prikaže napis WiFi.</p> 		<p>Pritisnite tipko "-" in izklopite modul.</p>  <p>Prikaže se ikona , ki potrjuje, da je bil ukaz za izklop modula pravilno izveden.</p>
<p>Za vklop Wi-Fi modula pritisnite tipko "F", dokler se na ekranu ne prikaže napis WiFi.</p> 		<p>Pritisnite tipko "+" in vklopite modul.</p>  <p>Prikaže se ikona , ki potrjuje, da je bil ukaz za vklop modula pravilno izveden.</p>
<p>S pritiskom na tipko "F" Wi-Fi modul preklopite nazaj v dostopno točko, kjer se nato lahko poveže na omrežje Wi-Fi. Tipko držite, dokler se na zaslonu ne prikaže napis WiFi.</p> 		<p>Pritisnite in držite tipko "+" vsaj tri sekunde:</p>  <p>Na zaslonu se prikaže beseda "AP", ki potrjuje, da se je modul povrnil v način dostopne točke.</p>

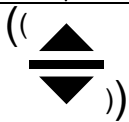
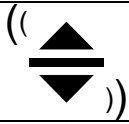



Stanje modula Wi-Fi je prikazano na zaslonu:

<p>Wi-Fi VKLOPLJEN in POVEZAN NA VELJAVNO OMREŽJE</p>	<p>Simbol je prižgan</p>	
<p>Wi-Fi VKLOPLJEN, a NI POVEZAN NA OMREŽJE ali POVEZAN NA OMREŽJE BREZ INTERNETNE POVEZAVE</p>	<p>Simbol utripa</p>	
<p>Wi-Fi VKLOPLJEN in pripravljen na začetno konfiguracijo</p>	<p>Simbol utripa</p>	
<p>Wi-Fi IZKLOPLJEN</p>	<p>Simbol ni prikazan</p>	

Opomba: Ko prižgete napravo, je potrebno počakati vsaj 30 sekund, da se vzpostavi povezava Wi-Fi omrežja in aplikacije. Če povezava ni uspešna, na zaslonu začne utripati simbol za Wi-Fi, aplikacija pa napravo prikaže kot nepovezano. V tem primeru izklopite napravo in ponovno poskusite vzpostaviti povezavo čez vsaj 30 sekund.

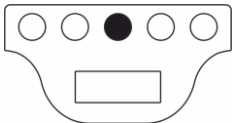
Za odpravljanje najpogostejših težav gl. odstavek 7.

6.4 Pripomočki

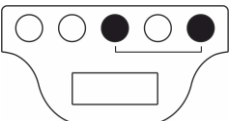
<p>Zaklepanje tipk</p> <p>Tipke na radiatorju lahko zaklenemo in tako preprečimo spreminjanje nastavitvev.</p> <p>Za zaklep tipk držite tipko "F".</p> 		<p>Na zaslonu se prikaže "LOC":</p> <p>Držite tipko "F" in s pritiskom tipke "+" zaklenite tipkovnico.</p>  <p>Na zaslonu se prikaže znak  in potrdi, da so tipke zaklenjene.</p> <p>Tipke odklenete tako, da držite tipko "F" in pritisnete tipko "-".</p> 
<p>V primeru, da je dotok energije prekinjen za več kot 30 minut in je vklopljena funkcija LOCK, radiator ob ponovnem zagonu deluje v tistem načinu delovanja, ki je bil vklopljen pred izpadom energije. Če pa je bil pred izpadom vklopljen program P1, se aktivira način Anti-freeze, saj je potrebno zopet vnesti podatke o dnevu in uri, da se programi lahko spet aktivirajo.</p>		

7. Odpravljanje težav

Problem	Rešitev
Radiator se ne prižge.	Preverite, ali je napajalnik vklopljen in da nazivna moč ustreza tisti, ki je navedena na nazivni ploščici radiatorja (npr. 230V~, 50Hz) ter da je stikalo na desni strani radiatorja prižgano ("I").
Radiator se ne ogreva.	Preverite, da je način delovanja pravilen. Če uporabljate enega izmed prednastavljenih programov, preverite, da za ta čas ni določen Anti-freeze način delovanja. Če je temperatura v prostoru višja kot zelena temperatura gretja, ni potrebe da bi radiator grel. Če dvomite v delovanje radiatorja, vklopite način Comfort in nastavite temperaturo Comfort mnogo višje, kot je temperatura prostora ter tako preverite, ali radiator deluje normalno.
Radiator ostaja vroč.	Preverite, da nastavljena temperatura ni previsoka ali da radiator ni v preprišnem prostoru, zaradi česar bi lahko bilo branje temperature v prostoru moteno.
Radiator se ne ogreje dovolj.	Preverite, da nastavljena temperatura ni prenizka in da radiator ogreva le prostor, kjer je nameščen (zapirajte vrata) in da je napajalno omrežje pravo.
Radiator se ogreva v načinu Eco.	To ni napaka v delovanju radiatorja. Radiator deluje, da ogreje do ali vzdržuje določeno Eco temperaturo.
Površina radiatorja je zelo vroča.	Normalno je, da je površina radiatorja med njegovim delovanjem vroča. Najvišje vrednosti so v skladu z omejitvami veljavnih varnostnih pravil. Če se vam radiator zdi zelo vroč, je morda premajhen za površino prostora, ki ga ogreva ali pa na njegovo delovanje vpliva preprišno okolje.

Temperatura v prostoru ni enaka nastavljeni temperaturi.	Potem, ko ste vsaj 4 ure čakali, da se temperatura prostora ustali, boste morda morali uravnati razliko med temperaturo v prostoru in tisto, ki je prikazana na radiatorju (glej poglavje 6.3).
Radiator oddaja neprijeten vonj.	Novi radiatorji lahko pri prvi uporabi oddajajo neprijeten vonj, kar je posledica samega proizvodnega procesa. Radiatorji, ki so že v uporabi, lahko oddajajo neprijeten vonj, če dalj časa niso bili prižgani in/ali jih uporabljamo v onesnaženih prostorih z zrakom slabe kakovosti.
Wi-Fi omrežje naprave ni vidno.	Skupaj s pametnim telefonom stopite v bližino radiatorja (ne bodite oddaljeni več kot 3 metre). Wi-Fi omrežje naprave je vidno v Wi-Fi nastavitvah vašega pametnega telefona, ne v aplikaciji.
Ne morete pričeti s konfiguracijo aplikacije, ker niste povezani na Wi-Fi omrežje naprave.	Če imate več kot le eno napravo, je priporočljivo, da konfigurirate eno napravo naenkrat, da vas ne zmedejo različna Wi-Fi omrežja naprav. Prepričajte, da ste vnesli pravo omrežno geslo Password123
Mobilna naprava je povezana na Wi-Fi omrežje naprave, a aplikaciji sporoča, da nobena naprava ni bila najdena.	Ne oddaljajte se od naprave, ko se skušate povezati z njo in izklopite ostala Wi-Fi omrežja, na katera bi se lahko pametni telefon samodejno povezal (razen tistega, na katerega se želite povezati). Na zaslonu radiatorja preverite, ali utripa ikona  . Če ne utripa, sledite navodilom in modul Wi-Fi vrnite v način dostopne točke in se ponovno poskusite povezati. Če je Wi-Fi omrežje pravilno aktivno, zaprite aplikacijo, jo ponovno odprite in znova dodajte napravo.
Aplikacija ne prikaže nobenega Wi-Fi omrežja, na katero bi se naprava lahko povezala.	Prepričajte se, ali je Wi-Fi omrežje naprave vklopljeno in da je jakost signala Wi-Fi v prostoru, kjer je naprava nameščena, dovolj močna. Preverite moč signala v prostoru, kjer je naprava nameščena. Če signal ni dovolj močan ali pa se jakost signala spreminja, lahko pride do napak v komunikaciji. V tem primeru je potrebno napravo premestiti na drugo lokacijo ali pa ojačati signal Wi-Fi omrežja.
Potem, ko ste izbrali Wi-Fi omrežje, na katerega bi se radi povezali, dobite sporočilo "The product cannot connect to the network" ("Naprava se ne more povezati na omrežje").	Preverite, da ste vnesli pravilno omrežno geslo. Preverite, da ima Wi-Fi omrežje, na katerega bi radi povezali napravo, aktivno internetno povezavo. Pritisnite tipko Retry, dokler povezava ni uspešna. Če povezava tudi po nekaj poskusih ni vzpostavljena, dajte napravo nazaj v način dostopne točke in jo izklopite za 1 minuto. Potem znova pričnite s postopkom povezave.

Če pride do kakršnega koli problema na Wi-Fi modulu, se na napravi prikaže koda napake, s katero lažje rešite problem:

Napaka	Opis	Rešitev problema
E01	Naprava se ne more povezati na Wi-Fi omrežje. Vneseno omrežno geslo za povezavo na Wi-Fi omrežje (ne Wi-Fi omrežje, ki ga oddaja naprava) je napačno ali omrežje ni več na voljo ali je ime omrežja spremenjeno.	Ponovite postopek registracije, tako da se zopet povežete z Wi-Fi omrežjem naprave in počakajte, da aplikacija zopet prikaže omrežja za povezavo. Izberite pravo omrežje in znova vnesite pravo geslo.
E02	Ni internetne povezave.	Znova vzpostavite internetno povezavo.
E03	Radialight server ni dosegljiv.	V teku je lahko vzdrževanje serverja. To navadno traja le nekaj ur. Počakajte in preverite, ali naprava še prikazuje kodo napake in ali je ikona za Wi-Fi še utripa. Če problem ostaja, odstranite napravo iz aplikacije, v načinu dostopne točke znova vklopite Wi-Fi omrežje naprave in ponovite postopek registracije naprave, kot pri novi napravi. Če napake niste odpravili po ponovni registraciji naprave, to pomeni, da je signal Wi-Fi, ki ga prejema radiator, prešibak ali se njegova jakost spreminja. Premestite napravo na drugo mesto ali pojačajte Wi-Fi signal .
E04	Naprava ni bila uspešno registrirana na server Radialight.	Resetirajte napravo v načinu dostopne točke in še enkrat od začetka ponovite postopek registracije naprave.
E05	Wi-Fi modul ni povezan.	Izklopite napravo z glavnim stikalom za 1 minuto in jo ponovno vklopite.
E06	Napaka Wi-Fi modula.	Če problem ni odpravljen, ugasnite napravo za vsaj eno uro, da se notranji spomin naprave izbrši in jo potem ponovno vklopite.

8. Vzdrževanje

- Naprava ne zahteva posebnega vzdrževanja..
- Napravo očistite s suho krpo vsakih 6 mesecev.
- Če je napravo treba popraviti, se obrnite na pooblaščen servis.
- Pri menjavi napajalnega kabla uporabite tip 2x1,00mm² ali 3x1,00 mm² H05V2V2-F HAR, odvisno od modela. Menjavo lahko izvede le primerno usposobljena oseba in nikoli končni uporabnik v izogib poškodbam naprave ali ogrožanju osebne varnosti.

9. Pravno obvestilo



Okolje in reciklaža

Prispevajte k ohranjanju čistega okolja in embalažo odvrzite v skladu s predpisi.

Reciklaža zastarelih naprav

Naprav s to oznako ne smemo odlagati skupaj s splošnimi odpadki, temveč jih je potrebno zbirati in odlagati posebej. Odlaganje rabljenih naprav mora potekati natančno in v skladu z veljavnimi predpisi in zakonodajo.

SL - Zahteve glede informacij za lokalne električne grelnike prostorov

Identifikacijska oznaka modela(-ov): KLIMA Wi-Fi					
Postavka	Simbol	Vrednost	Enota	Postavka	Enota
Izhodna toplotna moč				Način dovajanja toplotne moči, samo za lokalne električne akumulacijske grelnike (izberite eno možnost)	
Nazivna izhodna toplotna moč	P_{nom}	(*) glej Tabela 1	kW	Ročno uravnavanje dovajanja toplote z vgrajenim termostatom	ne
Minimalna izhodna toplotna moč (okvirno)	P_{min}	(*) glej Tabela 1	kW	Ročno uravnavanje dovajanja toplote s povratno informacijo o temperaturi v prostoru in/ali na prostem	ne
Največja trajna izhodna toplotna moč	$P_{max,c}$	(*) glej Tabela 1	kW	Elektronsko uravnavanje dovajanja toplote s povratno informacijo o temperaturi v prostoru in/ali na prostem	ne
Dodatna potreba po električni moči				Uravnavanje izhodne toplotne moči s pomočjo ventilatorja	ne
Pri nazivni izhodni toplotni moči	e_{lmax}	0,000	kW	Način uravnavanja izhodne toplotne moči/temperature v prostoru (izberite eno možnost)	
Pri minimalni izhodni toplotni moči	e_{lmin}	0,000	kW	Z enostopenjskim uravnavanjem izhodne toplotne moči, brez uravnavanja temperature v prostoru	ne
V stanju pripravljenosti	e_{lSB}	0,00049	kW	Z dvema ali več ročnimi stopnjami, brez uravnavanja temperature v prostoru	ne
				Z uravnavanjem temperature v prostoru z mehanskim termostatom	ne
				Z elektronskim uravnavanjem temperature v prostoru	ne
				Z elektronskim uravnavanjem temperature v prostoru z dnevnim časovnikom	ne
				Z elektronskim uravnavanjem temperature v prostoru s tedenskim časovnikom	da
				Druge možnosti uravnavanja (izberete lahko več možnosti)	
				Z uravnavanjem temperature v prostoru z zaznavanjem prisotnosti	da
				Z uravnavanjem temperature v prostoru z zaznavanjem odprtega okna	da
				Z možnostjo uravnavanja na daljavo	ne
				S prilagodljivim uravnavanjem začetka delovanja	ne
				Z omejitvijo časa delovanja	ne
				Z globus senzorjem	ne
Kontaktni podatki	Ermete Giudici S.p.A. - via L. da Vinci 27 - 20090 Segrate (MI) Italia				

Izhodna toplotna moč		KLIMA 7 KLIMA 7 AS	KLIMA 10	KLIMA 15	KLIMA 20
Izhodna toplotna moč					
Nazivna izhodna toplotna moč	P_{nom}	0,750	1,000	1,500	2,000
Minimalna izhodna toplotna moč (okvirno)	P_{min}	0,075	0,113	0,150	0,188
Največja trajna izhodna toplotna moč	$P_{max,c}$	0,750	1,000	1,500	2,000

ROMANA

MANUAL DE INSTALARE SI FOLOSIRE

Inainte de a utiliza incalzitorul, va rugam sa cititi cu atentie manualul de instructiuni, pentru a evita situatiile periculoase la care ati putea fi supusi. Orice utilizare a acestui aparat, alta decat cea prezentata in acest manual poate cauza ardere, socuri electrice sau raniri, si nu face obiectul garantiei aparatului.

Garantia nu se aplica in cazul oricaror defecte, deteriorari, pierderi, loviri sau daune datorate utilizarii incorecte a produsului. Raman in vigoare toate drepturile garantate de lege. Nici o conditie de garantie nu poate exclude sau modifica conditiile de garantie reglementate prin legile statului care nu pot fi in nici un mod modificate sau excluse.

Inainte de orice operatiune, indepartati cu grija ambalajul si controlati integritatea produsului. In cazul in care se observa defecte sau lovituri, nu instalati si nu incercati sa reparati aparatul, contactati furnizorul.

Nu lasati ambalajul la indemana copiilor si separati-l in parti componente in conformitate cu legile in vigoare.

1. Pentru siguranta d-vs.

- ❑ Acest aparat se adreseaza utilizarii casnice si nu pentru utilizare in autovehicule, la bordul navelor sau avioanelor.
- ❑ Acest produs nu trebuie utilizat de persoane (inclusiv copii) cu capacitati fizice, senzoriale sau mentale reduse sau cu experienta si cunostinte inadecvate, care nu sunt sub supravegherea unei persoane responsabile pentru siguranta lor sau care nu sunt instruite adecvat de catre o astfel de persoana. Copiii trebuie supravegheati pentru a va asigura ca nu se joaca cu aparatul. Curatarea si intretinerea nu se va face de catre copii fara supravegherea unui adult.
- ❑ Copiii sub 3 ani trebuie tinuti departe de aparat si supravegheati temeinic.
- ❑ Copiii intre 3 si 8 ani pot sa porneasca/opreasca aparatul cu conditia ca acesta sa fie pozitionat si instalat in pozitia dorita si functionand normal. Copiii trebuie instruiti in prealabil despre normele de siguranta si utilizare, operarea facandu-se in prezenta unui adult. Copiii intre 3 si 8 ani nu vor manevra stecherul conector la sursa de energie, nu vor regla, curata sau repara aparatul.
- ❑ **ATENTIE — parti ale aparatului pot deveni fierbinti in timpul functionarii si pot cauza arsuri. Atentie deosebita se va acorda copiilor si persoanelor vulnerabile atunci cand sunt in preajma aparatului.**
- ❑ Asigurati-va ca alimentarea de la retea corespunde cu datele de pe eticheta: 230VAC, 50Hz.
- ❑ Nu lasati copiii sau animalele sa atinga sau sa se joace cu aparatul. ATENTIE! Panoul se incalzeste in timpul functionarii si poate deveni foarte fierbinte. (aproximativ 80°C=176°F);
- ❑ **ATENTIONARE! Pentru a evita supraincalzirea, nu acoperiti aparatul! Nu agatati nimic pe incalzitor si nu il acoperiti in**

timpul functionarii. Acest lucru este inscriptiionat pe produs sau aratat de simbolul:



- Nu utilizati aparatul in incaperi cu gaze inflamabile sau in timp ce folositi solventi inflamabili, lacuri sau cleiuri.
- Daca firul de alimentare este deteriorat si trebuie schimbat, nu faceti asta singuri! Duceti produsul la un centru de reparatii autorizat sau la o persoana calificata pentru astfel de situatii, pentru a evita orice risc sau pericol.
- Aparatul trebuie amplasat in asa fel incat priza sa fie accesibila.
- Nu amplasati aparatul in imediata apropiere a prizelor.
- Nu introduceti obiecte sau hartie in radiator.

2. Produsul d-vs.

- Ce mai cuprinde pachetul pe langa aparatul de incalzire (image1):
 - N° 1 suporti metalici pentru montajul pe perete (fixati pe radiator);
 - N° 4 dibluri de plastic 8x50mm;
 - N° 4 5x60mm suruburi cap stea pentru a fixa suportii de perete;
- Adresati-va dealer-ului daca ceva este stricat sau lipseste.

3. Pozitionare corecta

- Montajul si utilizarea aparatului se va face doar in pozitia orizontala;
- Aparatul este construit cu dubla izolare electrica (clasa II) deci nu este necesara impamantarea;
- Atentie la distanta minima fata de pereti, mobilier si alte obiecte, asa cum se indica in imaginea 2;
- Nu instalati niciodata produsul pe suprafete de lemn sau din material sintetic.
- Aparatul are grad de protectie la apa IP24. Poate fi utilizat in bai si in spatii umede dar niciodata in perimetrul cazii sau dusului (volumul 1 din figura 3).
- Butoanele de reglare nu trebuie in nici un caz sa fie accesibile de catre persoanele care se afla in cada sau dus.
- Nu incastrati aparatul in mobilier, acest lucru duce la functionare defectuosa

4. Instalare

- Desfaceti suportii de fixare pe perete, de pe spatele radiatorului; desfaceti cele 2 cleme pozitionate pe partea superioara a aparatului , apoi celelalte 2 cleme din partea inferioara (vezi imaginea 4)
- Asezati suportul pe podea ca sa il folositi ca sablon pentru a marca punctele de fixare inferioare si a putea face gaurile (imaginea 5A)
- Ridicati suportul pana cand punctele inferioare coincid cu marcasele facute anterior pe perete. Folositi un creion pentru a marca pozitia a celor 2 puncte de fixare superioare. (imaginea 5B)
- Faceti gaurile in punctele marcate anterior si introduceti diblurile de plastic (imaginea 6)
- Fixati suportul pe perete folosind cele 4 suruburi din pachetul de instalare. (imaginea 7)
- Agatati aparatul pe suport incepand cu cele 2 puncte inferioare de fixare, dupa care apasati punctele de fixare pe pozitie (imaginea 8)
- În cazul în care va trebui să scoateți radiatorul din suport într-o etapă ulterioară, vă recomandăm să eliberarati cele 2 puncte de fixare de jos mai întâi și apoi cele superioare.

5. Conectarea electrica

- Aparatul trebuie alimentat la 230V AC 50Hz.
- Produsul poate fi furnizat cu cablu si stecher sau doar cu cablu pentru instalare. Daca aparatul se instaleaza in Franta conectati-l la rețeaua principala de electricitate prin taierea stecherului si legarea la rețea printr-o doza.
- Cand produsul este dotat cu cablu de alimentare, legarea trebuie efectuata utilizand trei fire (Maro=Faza, Albastru=Nul, Negru=Fir pilot) si o doza electrica. **Daca nu se doreste utilizarea functionalitatii firului pilot limitati-va la legarea fazei si nulului: produsul va functiona corect si fara prezenta programatorului extern.**
- In spatii umede, in bai sau bucatarii, conexiunea de legatura trebuie instalata la minim 25 cm de pardoseala

- ❑ Legatura electrica la retea trebuie sa fie prevazuta cu un intrerupator bipolar la o distanta minima de deschidere intre contacte de minim 3 mm. Respectati intotdeauna in mod prioritar regulile de instalare in vigoare din tara dumneavoastra.
- ❑ Legarea la impamantare este interzisa. **NU LEGATI LA IMPAMANTARE FIRUL PILOT (NEGRU).**
- ❑ Daca produsul trebuie alimentat prin intermediul unui intrerupator diferential de siguranta de 30mA, se poate ca firul pilot sa fie sub controlul intrerupatorului diferential.

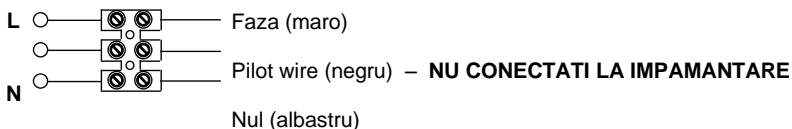

6. Utilizarea produsului

6.1 Descrierea functiilor

- A – Pornire / Stand-by
- B – Mod de functionare
- C – Functii speciale
- D – Crestere / Activare
- E – Descrestere / Dezactivare
- F – Afisaj
- G – Intrerupatorul principal

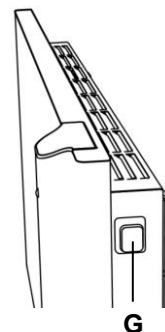
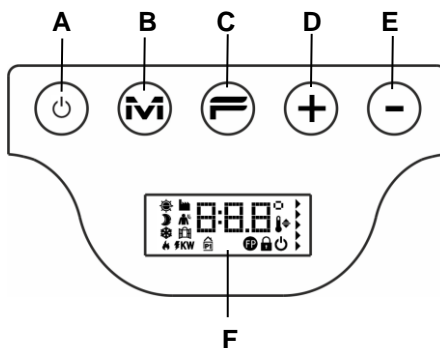





6.2 Functionare

6.2.1 Pornirea afisajului

<p>Daca afisajul nu este pornit, apasati orice buton ca sa il porniti. Afisajul se ilumineaza si ramane in stand-by pentru 30 de secunde dupa ultima apasare de buton</p>		<p>Cand afisajul este stins, la orice atingere a unui buton se ilumineaza fara a activa functia butonului apasat.</p>
---	--	---

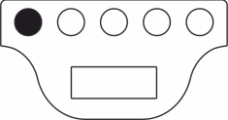

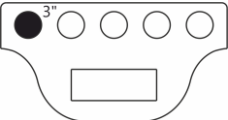

6.2.2 Pornirea si oprirea radiatorului

Alimentarea cu energie a radiatorului este controlata de un intrerupator electromecanic bipolar (G), localizat pe partea dreapta a radiatorului. Atunci cand intrerupatorul este oprit nu se alimenteaza nici placa electronica, ceea ce face ca toti parametrii salvati sa fie pierduti dupa 30 de minute si setarile din fabrica sa fie activate. Recomandam utilizarea intrerupatorului doar atunci cand radiatorul nu se foloseste perioade mai indelungate, in rest utilizati butonul Pornire / Stand-by (A) pentru a opri aparatul pentru perioade scurte de timp, in acest fel nu se vor pierde setarile salvate de d-vs.

<p>Cand radiatorul este pornit utilizand intrerupatorul principal de pe partea laterala, afisajul este iluminat si simbolul de stand-by este aratat.</p>		
<p>Pentru a porni radiatorul apasati butonul Pornire / Stand by</p> 		<p>Radiatorul vine din fabrica cu setarile pe modul confort. Daca aparatul este nou sau alimentarea cu energie a fost intrerupta mai mult de 30 de minute, aparatul se reseteaza pe valoarea din fabrica de 19°C.</p>
<p>Pentru a opri aparatul tineti apasat butonul Pornire / Stand-by pentru 3 secunde</p> 		<p>Oprirea aparatului de la intrerupatorul lateral pentru mai mult de 30 de minute duce la pierderea datelor salvate (data, ora, setarile de temperatura, etc.)</p>

6.2.3 Selectarea modului de operare

<p>Apasand butonul 'M' repetat va va permite sa selectati modul de functionare pe care il doriti.</p> 		<p>Modurile de functionare sunt activate in ordinea urmatoare:</p>  <p>Dupa trecerea celor 30 de sec. de la ultima apasare a tastei M, secventa modului de operare se reia de la inceput, pentru a face mai usor transferul de la orice mod de control catre modul Confort.</p>
---	---	---

Simbol	Descriere	Cand se utilizeaza
	Confort	Cand sunteti acasa radiatorul functioneaza pentru a mentine temperatura de confort setata de d-vs.
	Eco	Cand nu sunteti acasa pentru perioade scurte (de la 2 la 48 de ore) sau dormiti. Radiatorul functioneaza pentru temperaturii eco si economisire de energie.
	Anti-inghet	Cand sunteti plecat de acasa pentru perioade mai lungi de timp (mai mult de 48 de ore). Temperatura este automat setata la 7±3°C si nu poate fi schimbata.
	Program P1	Când doriți funcționarea programului prestabilit, potrivit pentru cei care nu lucreaza la domiciliu. Acest program poate fi personalizat urmând instrucțiunile enumerate la punctul 6.2.6.
	Firul pilot	Folosind o unitate de control extern cu un fir pilot. (Franta)

6.2.3.1 Descrierea programelor presetate :

	00:00 06:00 08:00 12:00 14:00 17:00 24:00
	Luni-Vineri □□□□□□ ■□□□□□ □□□□□□ □□□□□□ □□□□□□
Sambata-Duminica □□□□□□ ■□□□□□ ■□□□□□ ■□□□□□ ■□□□□□ ■□□□□□	
■ = temperatura "CONFORT" □ = temperatura "ECO" * = temperatura anti-inghet	

Programul P1 poate fi personalizat urmând instrucțiunile enumerate la punctul 6.2.6.

Setarea temperaturilor (valabil pentru toate programele):

- Selectati modul de functionare Confort si setati temperatura dorita.
- Selectati modul de functionare Eco si setati temperatura dorita.
- Selectati programul P1.







Rugam atentie: Cand selectati programul P1 fara sa fi setat inainte data si ora, sistemul va comuta automat la modul se functionare explicat in paragraful 6.2.5.

6.2.3.2 Utilizarea firului pilot

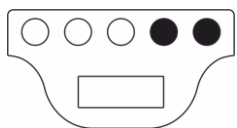

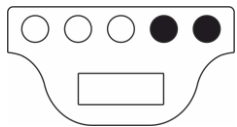



Daca firul de alimentare este furnizat fara stecher, radiatorul poate fi de asemenea folosit cu ajutorul unui programator special.

Temperatura de confort folosita in modul FIR PILOT este setata asa cum a fost deja explicata pentru programele presetate, prin trecerea mai intai de la modul CONFORT, utilizand butonul "M" apoi selectand valoarea dorita utilizand butoanele "+" si "-".

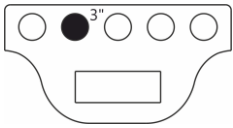
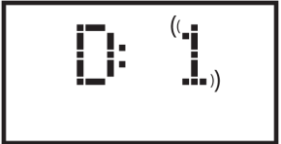
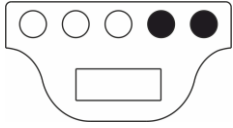
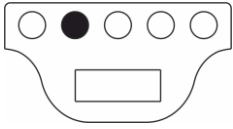
6.2.4 Reglarea temperaturii

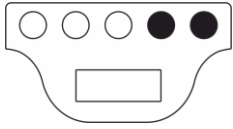
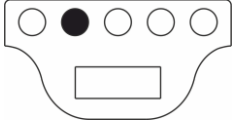
Radiatorul este caracterizat de 2 temperaturi de referinta confort si eco, care pot fi setate independent.		O sageata la dreapta ecranului se misca de-a lungul unei scale de la verde la rosu pentru a indica daca temperatura difera mai mult sau mai putin de valoarea recomandata de 19°C.
Temperatura presetata este de 19,0°C si poate fi schimbata folosind butoanele "+" si "-". 		Daca temperatura de confort este setata la o valoare mai mica decat temperatura eco, aceasta din urma este automat modificata cu -0,5°C mai putin fata de valoarea de confort.
Temperatura ECO presetata este de 15,5°C si poate fi schimbata utilizand butoanele "+" sau "-". 		Diferenta recomandata intre temperatura de confort si ECO este de 3,5 °C. Daca diferenta setata difera de valoarea sugerata, simbolul ECO se va schimba dupa cum urmeaza:  Valoarea maxima pe care o puteti seta pentru temperatura ECO este cu 0,5°C mai mica decat temperatura de confort.
Daca temperatura ambientala este mai mica decat temperatura setata si aratata pe ecran, indicatorul de caldura va porni pe ecran  .		

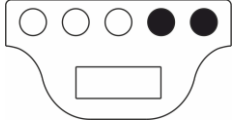
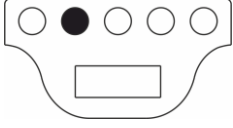
6.2.5 Setarea zilei si orei

<p>Ziua si ora sunt necesare pentru a putea folosi cele 3 programe presetate, aceasta se poate face tinand apasata tasta M (mod de functionare).</p> 		<p>Litera D palpaie si poate fi setata ziua (1= Luni), pentru a modifica apasati butoanele "+" sau "-".</p> 
<p>Apasati butonul M (mod de functionare) pentru a confirma ziua setata si a trece la setarea orei.</p> 		<p>Litera H palpaie si poate fi setata ora, pentru a modifica apasati butoanele "+" sau "-".</p> 
<p>Apasati butonul M (mod de functionare) pentru a confirma ora setata si a trece la setarea minutelor.</p> 		<p>Litera M palpaie si poate fi setat minutul, pentru a modifica apasati butoanele "+" sau "-".</p> 
<p>Apasati butonul M (mod de functionare) pentru a confirma fixarea minutelor si a confirma aceste setari.</p> 		<p>Sistemul se va intoarce la modul de operare activat la inceputul programarii.</p> <p>Daca incercati sa activati un program presetat fara a salva ora si data, aceasta procedura de programare se va activa automat.</p>



6.2.6 Personalizarea Programului P1







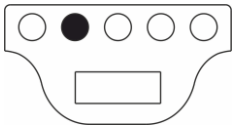

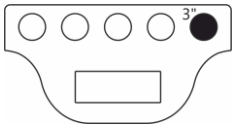
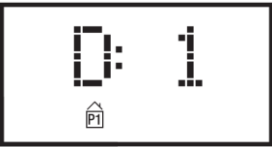
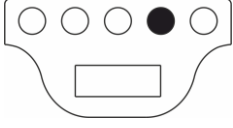

Programul P1 poate fi modificat pentru a raspunde nevoilor utilizatorului. Modificarile P1 dau utilizatorului posibilitatea de a seta temperatura ambientalata dorita, alegand intre CONFORT, ECO, sau ANTI-INGHET, pentru fiecare ora a zilei si a intregii saptamani.

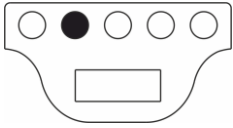
Reveniti la paragraful 6.2.4 pentru a seta temperaturile la fiecare Mod de functionare.

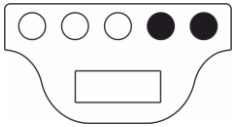
Fiecare ora afisata, arata nivelul temperaturii programului P1 ales de d-vs. La prima utilizare a aparatului profilul programului P1 este cel indicat in paragraful 6.2.3.1.

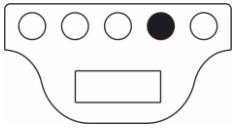
pentru a modifica sau afisa programul P1, urmati pasii:

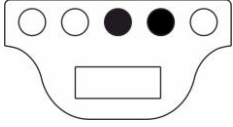
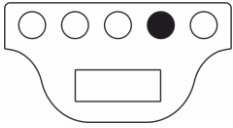
<p>Apasati tasta "M" pentru a selecta programul P1.</p> 		<p>In cazul in care ORA nu a fost setata anterior (produs nou sau date pierdute datorita lipsei de energie electrica mai mult de 30 min.) procedura de reglare a orei se va activa automat. (vezi paragraful 6.2.5)</p>
---	---	---

<p>Pentru a afisa P1 apasati butonul “-” pentru 3 secunde.</p> 		<p>Prima zi pe care o vedeti (1= Luni)</p>
<p>Apasati butonul “+” pentru a accesa ORA vizualizare/modificare.</p> 		<p>Apasati butonul “M” pentru a alege temperatura dorita intre CONFORT, ECO, ANTI-INGHET</p>   <p>Dupa setarea zilei si orei, temperatura afisata este cea aleasa pe programul P1.</p>
<p>Folositi butoanele “+” si “-” pentru a introduce fiecare ora pentru ziua 1 si a vedea/modifica temperatura de lucru pentru fiecare din ele.</p> 		<p>Ora afisata indica intotdeauna punctul de pornire. De ex.: cand este afisat H:23, modificarile privesc intervalul de timp dintre 23:00 si 00:00.</p>
<p>Dupa ce ati terminat de modificat temperatura pentru fiecare din cele 23 de ore pentru ZIUA 1, mai departe apasati butonul “+” pentru a introduce modificarile ZILEI 2.</p> 		<p>Apasati butonul “+” pentru a afisa/modifica temperatura de lucru pentru fiecare ora a ZILEI 2 asa cum s-a descris pentru ZIUA 1. Puteti seta automat acelasi program al ZILEI 1 pentru ZIUA 2, prin tinand apasat butonul “F” si si apasand butonul “+”.</p>  <p>Nota: puteti sa programati automat acelasi program zilnic DOAR CAND numarul zilei care doriti sa o ajustati este afisat (asa cum se arata in imagine), DAR NU atunci cand este afisata ora.</p>
<p>Odata ce ultima zi (ZIUA) a fost setata, apasati butonul “+” pentru a termina sesiunea de programare.</p> 		<p>END (SFARSIT) va aparea pe ecran. O alta apasare a butonului “+” va confirma programul ales de d-vs.</p>

“OK” va apare pe ecran pentru 5 secunde, confirmand ca sesiunea de programare a fost incheiata cu succes. Sistemul este acum programat sa moduleze temperatura conform noilor modificari ale programului P1.



Nota: este posibil sa iesiti oricand din sesiunea de programare fara a afisa fiecare ora pana la ZIUA 7, pentru aceasta tineti apasat butonul “F” si apoi apasati butonul “-”.

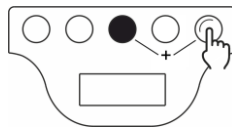











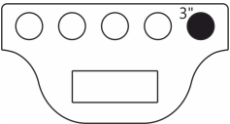
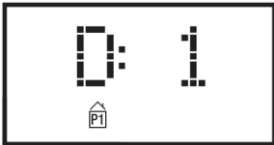

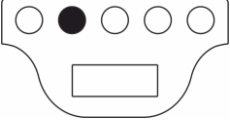

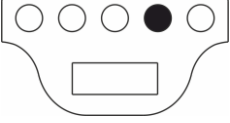
N.B.:

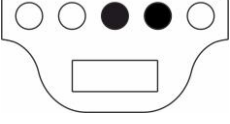
- Puteti abandona sesiunea de afisare/modificare in orice moment, anuland orice setari ce nu au fost salvate, doar prin apasarea butonului “Stand-By” (A).
- Restaurarea setărilor implicite va sterge orice setare a Programului P1 creata anterior. (vezi paragraful 6.3)
- Daca timp de 90 de secunde, nu se apasa nici un buton, in timpul sesiunii de programare, va avea ca rezultat anularea procedurii de afisare/modificare si se va reintoarce la setarile implicite din fabricatie.
- In timpul procesului de programare, elementele de incalzire vor intra automat in modul Stand-By si radiatorul nu va incalzi.

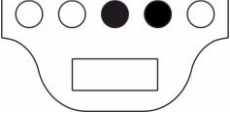

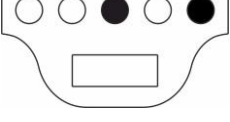

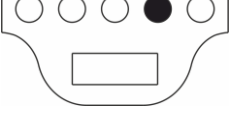





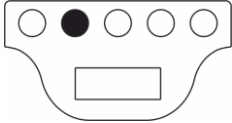

EXEMPLU: CUM SA SETEZI UN PROGRAM PERSONALIZAT

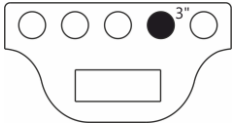

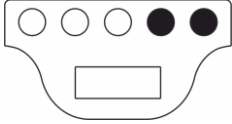

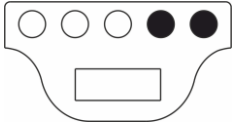

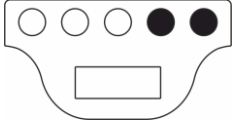
Haideti sa vedem cum programam un aparat nou si anticipam trecerea de la temperatura ECO la CONFORT cu o ora inainte (06:00 a.m. este setarea din fabricatie), pentru fiecare zi incepand de luni pana vineri.

<p>Apasati “M” pentru a alege programul P1</p>		
<p>Setati ziua curenta a saptamanii (prima utilizare a radiatorului), prin apasarea butoanelor “+” sau “-” .</p>		
<p>Apasati “M” si setati ora curenta (prima utilizare a radiatorului) prin apasarea butoanelor “+” sau “-” .</p>		
<p>Apasati “M” si setati minutul curent (prima utilizare a radiatorului) prin apasarea butoanelor “+” sau “-” .</p>		
<p>Apasati “M” pentru a incheia procedura de programare. Acum sistemul se intoarce la programul P1.</p>		

<p>Tineti apasat “-” pentru 3 sec. Pentru a introduce afisarea/modificarea ZILEI 1.</p>		
<p>Apasati “+” pana vedeti H:05 pe ecran (aceasta este ora la care dorim sa modificam temperatura ECO la CONFORT)</p>		
<p>Apasati “M” de 2 ori pentru a schimba nivelul de temperatura de la ECO la CONFORT.</p>		
<p>Apasati butonul “+” pana va aparea pe ecran D:2 (Marti)</p>		
<p>Pentru a copia acelasi program al ZILEI 1 si in ZIUA 2 tineti apasat butonul “F” si apoi butonul “+” . sistemul va prelua automat programul si va afisa direct ZIUA 3 (Miercuri).</p>		
<p>Repetati procedura descrisa anterior pana cand este afisat pe ecran D:6.</p>		
<p>Din moment ce nu doriti să modificați ZIUA 6 si 7, putem iesi din modul de programare prin tinerea apasata a butonului “F” si apoi apasarea butonului “-” “END” (SFARSIT) va aparea pe ecran.</p>		
<p>Apasati “+” pentru confirmarea procesului de modificare. “OK” va palpai pe ecran timp de 5 secunde.</p>		

6.3 Functii speciale

<p>Apasand repetat butonul "F" face posibila alegerea diferitelor functii speciale in sesiunea de programare.</p> 		<p>Pentru a iesi din meniul cu functii speciale, asteptati doar 12 sec. Sau apasati butonul "M" pentru a va intoarce la afisarea modului de operare.</p> 
<p>Reinstituirea setărilor implicite</p> <p>Notă: Restaurarea setărilor din fabrică NU va anula nici o setare de conexiune Wi-Fi salvată anterior.</p>		<p>Pentru a reveni la parametrii impliciti ai radiatorului setati de fabricant, tineti apasat pentru cel putin 3 sec. butonul "+"</p> 
<p>Wi-Fi</p> <p>Datorită acestei funcții, este posibil să conectați radiatorul la rețeaua Wi-Fi cu acces la internet și să îl controlați prin aplicație.</p> <p>Pentru mai multe detalii, consultați punctul 6.3.3.</p>		<p>Activarea (ON) sau dezactivarea (OFF) a acestei funcții se obțin apăsând respectiv "+" sau "-".</p>  <p>Activarea este indicată de pictograma relativă afisata pe ecran</p> 
<p>Senzor de prezenta</p> <p>Aceasta functie permite radiatorului sa detecteze daca sunt sau nu persoane in incapere, si automat sa isi moduleze nivelul temperaturii, pentru un consum cat mai redus si asigurarea unei temperaturi confortabile.</p> <p>Pentru mai multe detalii vezi paragraful 6.3.1.</p>		<p>Comutarea functiei (ON) sau (OFF) se face prin apasarea butoanelor "+" sau "-".</p>  <p>Activarea este indicata de aparitia pe ecran a simbolului</p> 
<p>Senzor fereastra deschisa</p> <p>Aceasta functie face posibila detectia ferestrei deschise si va activa automat modul de operare ANT-INGHET.</p> <p>Pentru mai multe detalii vezi paragraful 6.3.2.</p>		<p>Comutarea functiei (ON) sau (OFF) se face prin apasarea butoanelor "+" sau "-".</p>  <p>Activarea este indicata de aparitia pe ecran a simbolului</p> 

<p>Consum zilnic</p> <p>Aceasta functie da posibilitatea se a vizualiza cantitatea de energie electrica pe care radiatorul a consumat-o in ultimele 24 de ore.</p>		<p>Daca indicatorul de consum palpaie, aceasta inseamna ca datele salvate se refera la o perioada mai scurta de 24 de ore.</p> <p>Observatie: ecranul arata consumul estimat, care este posibil sa difere de cel dat de un aparat special de masurare.</p>
<p>Consumul saptamanal</p> <p>Aceasta functie da posibilitatea se a vizualiza cantitatea de energie electrica pe care radiatorul a consumat-o in decurs de 7 zile.</p>		<p>Daca indicatorul de consum palpaie, aceasta inseamna ca datele salvate se refera la o perioada mai scurta de 7 zile.</p> <p>Observatie: ecranul arata consumul estimat, care este posibil sa difere de cel dat de un aparat special de masurare.</p>
<p>Afisare temperatura ambientala</p>		<p>Ecranul arata temperatura ambientala masurata de radiator.</p>
<p>Alinierea temperaturii ambientale</p> <p>Aceasta functie este folosita pentru a modifica temperatura ambientala masurata de radiator si folosita pentru a regla puterea de incalzire, daca necesita corectie pentru a compensa erorile datorate lucrurilor sau curentilor de aer rece din apropierea aparatului.</p>		<p>Pe ecran palpaie valoarea de corectie care va fi aplicata. Pentru editare apasati butoanele "+" or "-".</p>  <p>Daca de exemplu temperatura setata pe radiator este de 19,2°C si temperatura ambientala masurata este de 19,5°C, aliniasi cu +0,3°C</p> <p> Intotdeauna asteptati cel putin 4 ore pentru ca temperatura sa se stabilizeze, inainte sa mai faceti vreo aliniere.</p>

6.3.1 Senzor de prezenta

Aceasta functie permite radiatorului sa detecteze daca sunt sau nu persoane in incapere si automat sa isi moduleze nivelul temperaturii, pentru un consum cat mai redus si asigurarea unei temperaturi confortabile.

Datorita acestei functii, care poate fi activata doar in modul CONFORT, radiatorul monitorizeaza constant incaperea si daca nu detecteaza persoane isi reduce temperatura de confort dupa cum urmeaza:

Perioada de absenta	Reducerea temperaturii de Confort	Indicatii pe ecran
60 min	1,0°C	<p>Simbolurile senzorului de prezenta si modului Confort palpaie impreuna.</p> 
90 min	2,0°C	
120 min	3,5°C	
38 ore	Anti-inghet activat 7±3°C	

Reducerea temperaturii se raporteaza intotdeauna la temperatura de CONFORT. Daca radiatorul este in modul ECO sau ANTI_INGHET nu se va observa nici o schimbare a temperaturii de mentinere in incapere.

Daca o persoana va fi detectata in incapere pentru cel putin 10 minute consecutive, temperatura se va intoarce la modul confort setat, fara nici o reducere. La fel se intampla daca, in timp ce temperatura ceruta este redusa datorita absentei persoanelor in incapere, atunci tasta "M" este apasata.

Important:

operarea corecta a acestei functii poate depinde de locul unde radiatorul este pozitionat in camera. Pentru a alege cea mai buna pozitie de instalare, luati in considerare ca senzorul vede orice miscare intr-o arie indicata in figura 9 de mai jos si ca nici un obiect nu trebuie sa fie in raza. Senzorul de prezenta este eficient atunci cand persoanele se misca in fata lui sau inspre el.

6.3.2 Senzor fereastra deschisa

Aceasta functie face posibila detectia ferestrei deschise si va activa automat modul de operare ANTI_INGHET.

Daca detecteaza o schimbare brusca de temperatura in timp ce aparatul functioneaza, modul ANTI_INGHET se va activa automat pentru a reduce pierderea de energie. Pe ecran va fi afisata o fereastra si simbolul ANTI_INGHET palpaind impreuna, in timp ce simbolul pentru modul de functionare setat de utilizator rămâne.

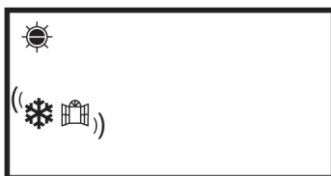

Repornirea functionarii normale nu se face automat, ci prin apasarea butonului "M".





Important:

Functionarea corecta a acestei functii poate depinde de locul unde este pozitionat aparatul in incapere, de prezenta mobilierului, temperatura exteriora si cat timp sta fereastra deschisa.

6.3.3 Utilizarea APP

Datorită acestei funcții, este posibil să conectați radiatorul la o rețea Wi-Fi cu acces la internet și să îl controlați prin aplicația dedicată Radialight®.

Pentru a conecta produsul la rețeaua Wi-Fi, puteți urma instrucțiunile furnizate direct în aplicație sau consultați ghidul detaliat care ilustrează procedura pas cu pas. Alegeți ghidul pentru sistemul dvs. de operare:

	android	iOS
DESCARCA APLICAȚIA	 www.radialight.com/app-android	 www.radialight.com/app-ios
DESCOPERI GHIDUL RAPID DE PORNIRE	 www.radialight.com/android-start-guide	 www.radialight.com/ios-start-guide

După finalizarea conexiunii, pe aplicație este afișată următoarea pagină de pornire:

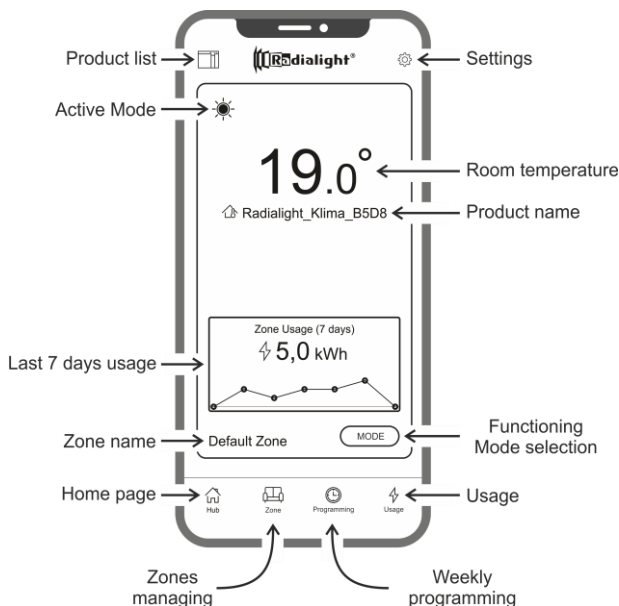

Lista de produse: vă permite să vizualizați lista cu toate produsele înregistrate și să adăugați altele noi. Modul de funcționare actual activ, numele zonei de produs și indicatorul de încălzire sunt afișate pentru fiecare produs. Alte opțiuni vă permit să modificați zona de apartenență, numele produsului și să dezactivați produsul. Prin glisarea pictogramei produsului de la dreapta la stânga, veți găsi un buton care vă permite să îl ștergeți și să îl ștergeți din lista de produse.

Mod activ: o pictogramă reprezintă modul activ folosind același simbol pe afișajul produsului. Dacă modul programat este activ, simbolul ceasului este flancat de pictograma modului de operare programat. Numele activ al programului este afișat și în dreapta acestui simbol.

Utilizarea ultimelor 7 zile: este afișat consumul de energie din ultimele 7 zile, iar tendința de consum este reprezentată grafic pentru fiecare zi. Apăsând pe grafic accesați secțiunea de analiză a utilizării.

Nume zonă: indică numele atribuit zonei și poate fi personalizat urmând instrucțiunile de mai jos.

Gestionarea zonelor: vă permite să vizualizați lista de zone definite și să le ștergeți sau să le creați. Pentru fiecare zonă este indicat numele și modul activ și este disponibilă o cheie pentru a schimba modul de operare al tuturor produselor din zonă.

Programare săptămânală: prin apăsarea acestei pictograme accesați secțiunea de programare săptămânală. În această secțiune este posibil să modificați programul prestabilit prestabilit sau să le creați noi. Fiecare program poate fi asociat cu un nume și o culoare personalizate pentru a facilita identificarea. Anularea unui program se poate face prin glisarea pictogramei programului de la dreapta la stânga.

Utilizare: apăsând această pictogramă puteți accesa secțiunea de analiză a utilizării și puteți vizualiza datele colectate zilnic, săptămânal sau lunar - împărțite în funcție de zonă sau grupate.

Selectarea modului de operare: vă permite să selectați modul de operare alegând între confort, eco, antigel, programat, fir pilot și stand-by. Dacă doriți, această variație poate fi cronometrată: la sfârșitul timpului setat, modul activ va reveni la cel setat înainte de modificare.

Nume produs: numele produsului este afișat în centrul afișajului. Dacă o zonă include mai multe produse, informațiile relevante (numele și temperatura camerei) sunt afișate în secvență.

Temperatura camerei: este afișată temperatura măsurată de senzorul produsului.

Setări: în această secțiune este posibil să:

- Vizualizați tutorialul care explică modul în care funcționează aplicația;
- Activarea controlului costurilor care permite adăugarea la valoarea kWh și a unei valori economice, specificând costul unitar al energiei;
- Gestionați notificarea utilizatorului dacă senzorul de fereastră deschis este activat și intră în funcțiune;
- Gestionați notificarea utilizatorului dacă unul sau mai multe produse sunt în modul Standby, în timp ce zona din care fac parte sunt setate într-un mod diferit;
- Gestionează notificarea utilizatorului dacă este depășit un prag de consum sau de cheltuieli stabilit;
- Schimbați parola contului;
- Schimbarea actualizărilor și a acordului de primire a promoțiilor.

Apăsând centrul zonei puteți accesa vizualizarea detaliată a setărilor zonei:

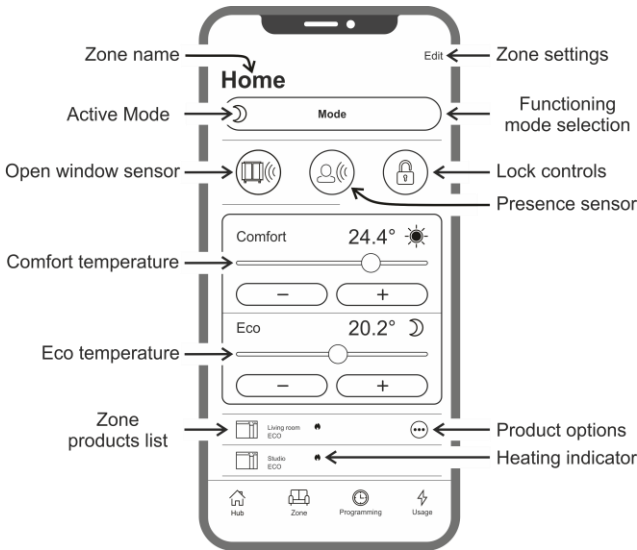

Senzor pentru fereastră deschisă: vă permite să activați sau să dezactivați detectarea deschiderii unei ferestre (vezi secțiunea 6.3.2).

Senzor de prezență: vă permite să activați sau să dezactivați funcția de reducere a temperaturii Comfort dacă camera nu este ocupată o anumită perioadă de timp (vezi secțiunea 6.3.1).

Control de blocare: vă permite să blocați tastele de reglare ale produsului, prevenind modificări accidentale sau neautorizate (vezi secțiunea 6.4).

Lista de produse din zonă: toate produsele aparținând zonei selectate sunt listate în partea de jos a ecranului. Fiecare arată numele său, modul de funcționare activ și starea de încălzire.

Indicator de încălzire: pictograma se aprinde atunci când temperatura camerei este mai mică decât cea dorită și produsul funcționează pentru a încălzi camera.

Opțiuni de produs: vă permite să schimbați zona de apartenență, numele produsului sau să o dezactivați.

Setări zonă: vă permite să schimbați numele zonei și imaginea de fundal.

Neconcordanțele

Dacă o zonă conține 2 sau mai multe produse și unul sau mai multe dintre ele au o setare diferită de cea setată pentru zonă, apare o inconsecvență.

Această situație, de obicei datorată modificării manuale a unui parametru de produs, se poate referi la modul de operare, la starea senzorilor sau la valorile de temperatură Confort și Eco.

Dacă apare această afecțiune, aplicația evidențiază parametrul zonei inconsistente prin afișarea unui simbol special, așa cum se arată în imaginea din dreapta.

Același simbol apare în colțul din stânga sus al pictogramei produsului prezentat în lista din partea de jos a ecranului. În acest fel, utilizatorul este informat despre produsul care rezultă pentru a avea una sau mai multe setări care nu sunt congruente cu cele definite pentru zonă.

Apăsând simbolul de inconsistență, este posibil să resetați toate produsele cu parametrii selectați anterior pentru zonă.

Dacă modificarea setărilor unuia sau mai multor produse a fost intenționată, este posibil să ignorați simbolurile afișate. Cu toate acestea, dacă utilizarea de setări diversificate este recurentă, este recomandabil să se alocă produsele în zone diferite, astfel încât să le poată gestiona fără afișarea continuă a simbolurilor de inconsistență.

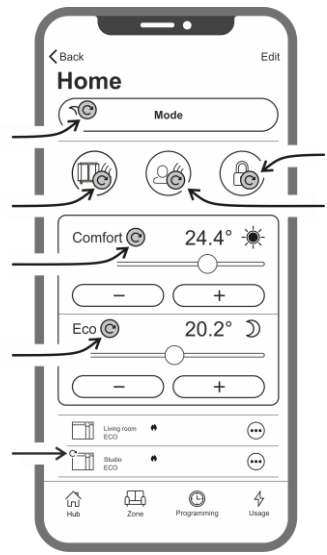

Bine de stiut:

Gestionarea timpului

Setarea curentă a orei și zilei săptămânii este transmisă radiatorului la momentul înregistrării inițiale. În același timp, este memorat fusul orar al zonei în care este instalat produsul.

Gestionarea timpului de vară nu este automată, dar va fi suficient să trimiteți orice comandă în zonă după schimbarea timpului pentru a vă asigura că produsele aparținând zonei sunt resetate cu ora corectă.

Pana de curent

Dacă alimentarea este deconectată mai mult de 30 de minute, radiatorul pierde multe dintre setările sale interne. Când alimentarea revine, produsul se reconectează automat la rețeaua Wi-Fi și setează modul Stand-by. Prin urmare, este recomandat să verificați detaliile zonei pentru a controla dacă modul setat în aplicație și cel prezent pe produs sunt identice. În secțiunea Setări este posibilă activarea notificării utilizatorului dacă produsele sunt detectate în modul Stand-by în timp ce zona din care fac parte sunt setate într-un mod diferit.

Notificări









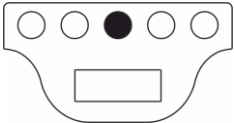

În secțiunea Setări puteți defini dacă doriți sau nu să primiți notificări atunci când apar evenimente specifice. Notificările sunt afișate, cu aplicația deschisă sau închisă, dacă au fost autorizate în timpul instalării aplicației. Pentru a verifica starea de activare a notificărilor, consultați instrucțiunile sistemului de operare al smartphone-ului dvs.

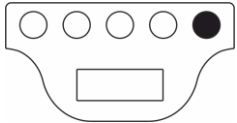
Puterea semnalului Wi-Fi

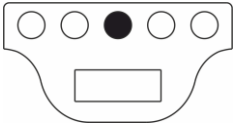

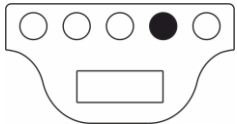
Dacă radiatorul a fost instalat într-o zonă în care semnalul rețelei dvs. Wi-Fi este slab, este posibil să experimentați o anumită lentoare în executarea comenzilor trimise prin aplicație sau chiar întreruperea temporară a comunicațiilor. Pentru a rezolva problema este necesară creșterea intensității semnalului în zona de instalare.

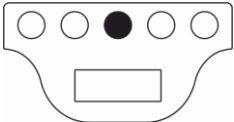
Gestionarea modului Wi-Fi:

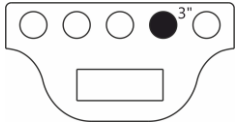
Modulul Wi-Fi poate fi pornit, oprit sau raportat în modul punct de acces în funcție de nevoile dvs.

<p>Pentru a opri modulul Wi-Fi, apăsați tasta „F” până când pe afișaj apare cuvântul WiFi.</p> 		<p>Apăsați tasta "-" pentru a opri modulul.</p>  <p>Oprirea pictogramei confirmă executarea corectă a comenzii.</p> 
<p>Pentru a porni modulul Wi-Fi, apăsați tasta „F” până când apare pe ecran cuvântul WiFi.</p> 		<p>Apăsați tasta "+" pentru a porni modulul.</p>  <p>Pornirea pictogramei confirmă executarea corectă a comenzii.</p> 
<p>Pentru a readuce modulul Wi-Fi în modul Access Point și gata de conectare la o rețea Wi-Fi, apăsați tasta „F” până când apare pe ecran cuvântul WiFi.</p> 		<p>Apăsați tasta "+" pentru 3 "pentru a reseta modulul.</p> 

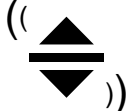



Starea modulului Wi-Fi este afișată pe afișaj printr-o mică pictogramă din partea dreaptă.

Wi-Fi pornit și conectat la o rețea funcțională	Simbolul sta aprins	
Wi-Fi ACTIVAT, dar NECONECTAT LA O REȚEA sau conectat la o rețea FĂRĂ INTERNET	Simbolul clipește	
Wi-Fi ON și gata pentru configurația inițială	Simbolul clipește	
Wi-Fi închis	Simbolul nu e vizibil	

Notă: După pornirea produsului, conexiunea la rețeaua Wi-Fi și aplicația necesită cel puțin 30 de secunde de așteptare. Dacă operațiunea nu are succes, simbolul Wi-Fi clipește, iar aplicația arată produsul ca fiind deconectat. În acest caz, este necesar să opriți radiatorul cel puțin 30 de secunde înainte de a încerca din nou.

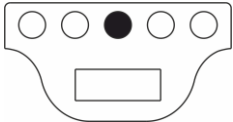
Consultați paragraful 7 pentru depanarea problemelor cele mai frecvente și explicația codurilor de eroare.

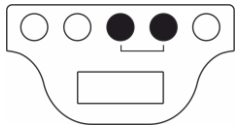
6.4 Utile

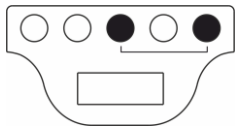
<p>Blocare butoane</p> <p>Butoanele radiatorului pot fi blocate pentru a preveni ca setarile sa fie modificate accidental sau de persoane neavizate. Pentru activare mergeti la modul lock/unlock (inchis/deschis), tineti apasat butonul "F",</p> 		<p>Pe ecran apare "LOC" (inchis): tineti apasat butonul "F" si apasati tasta "+" pentru a bloca consola de comanda.</p>  <p>activarea este indicata de simbolul care apare pe ecran </p> <p>tineti apasat butonul "F" si apasati tasta "-" pentru a debloca consola de comanda.</p> 
<p>Cand aceasta functie este activata, in cazul in care curentul revine dupa o intrerupere de peste 30 min, este reluat modul de functionare setat inainte de intrerupere. Daca modul de functionare a fost unul din cele trei programe P1, functionarea va fi reluata pe programul anti-inghet, deoarece vor trebui reintroduse data si ora inainte de folosirea unuia din cele trei programe.</p>		

7. Depanare

Problema	Solutie
Radiatorul nu porneste.	Verificati daca sursa de energie este pornita si ca este asa cum indica placutele radiatorului (e.g. 230 Vac 50 Hz) si intrerupatorul principal este pornit pe pozitia I.
Radiatorul nu se incalzeste	Asigurati-va ca functioneaza pe modul dorit daca utilizati un program presetat. Daca temperatura ambientala este mai mare decat cea setata, radiatorul nu ar trebui sa se incalzeasca. Daca nu sunteti sigur, setati modul CONFORT si temperatura doritamai mare decat cea din incapere, pentru a verifica daca radiatorul functioneaza corect.
Radiatorul ramane fierbinte	Verificati ca temperatura nu este prea mare sau ca nu sunt obstacole langa radiator care ar putea altera temperatura ambientala masurata.
Radiatorul nu incalzeste suficient	Verificati ca temperatura setata nu este prea mica si ca aparatul incalzeste incaperea pentru care a fost destinat (tineti usile inchise) . Verificati alimentarea cu energie sa se faca corect.
Radiatorul incalzeste in modul Eco.	Radiatorul se poate incalzi pentru a ajunge / mentine temperatura ECO. Nu este o functionarea anormala.
Suprafata radiatorului este foarte fierbinte.	Este normal sa fie fierbinte in timpul functionarii. Valoarea maxima se incaderaza la limitele date de normele de siguranta. Daca radiatorul este intotdeauna foarte fierbinte, este posibil sa fie subdimensionat pentru incaperea in care este folosit sau poate fi afectata functionarea lui de obstacole.
Temperatura din camera difera de temperatura setata	Asteptati ca temperatura ambientala sa se stabilizeze, cel putin 4 ore si apoi puteti modifica temperatura pentru a compensa intre temperatura aratata de radiator si cea masurata in camera. Vedeti paragraful 6.3 sectiunea alinierea temperaturii ambientale".

Radiatorul emana un miros neplacut	Atunci cand radiatorul este nou, este posibil ca la prima utilizare sa degaje un miros neplacut, datorat unor reziduri din procesul de fabricatie. Radiatoarele care au fost deja utilizate degaja miros neplacut daca nu sunt utilizate o perioada mai lunga si/sau sunt folosite in spatii poluate sau incaperi cu aerisire slaba.
Imposibil de vizualizat rețeaua Wi-Fi generată de produs.	Poziționează-te cu smartphone-ul tău la o distanță de cel mult 3m de produs. Rețeaua Wi-Fi generată de produs este afișată în setările Wi-Fi ale smartphone-ului și nu în aplicație.
Nu se poate conecta la rețeaua Wi-Fi generată de produs pentru a începe procesul de configurare a aplicației.	Dacă aveți mai multe produse, vă recomandăm să porniți și să configurați un singur produs simultan, să nu obțineți confuz de diferitele rețele Wi-Fi generate. Asigurați-vă că ați introdus corect parola de rețea Parolă123
Dispozitivul mobil se conectează la rețeaua Wi-Fi creată de produs, dar aplicația arată un mesaj care indică faptul că nu a fost găsit niciun produs.	Nu vă îndepărtați de produs în timp ce vă conectați și dezactivați orice altă rețea Wi-Fi la care smartphone-ul se poate conecta automat (cu excepția celei la care doriți să conectați produsul). Verificați pe afișajul produsului dacă modulul Wi-Fi este activ, verificând că pictograma este aprinsă și clipește. Dacă nu, urmați instrucțiunile pentru a readuce produsul în modul Acces Point și încercați din nou. Dacă Wi-Fi-ul produsului este activ corect, închideți aplicația, redeschideți-o și apoi adăugați noul produs ca operațiune.
Aplicația nu afișează nicio rețea Wi-Fi la care să conectați produsul.	Asigurați-vă că rețeaua Wi-Fi la care doriți să conectați produsul este pornită și că semnalul ajunge în zona în care este instalat produsul. Verificați intensitatea semnalului în zona în care este instalat produsul. Semnalele care sunt prea mici sau care variază intensitatea pot crea probleme de comunicare. În acest caz, trebuie să mutați produsul într-o locație nouă sau să îmbunătățiți semnalul rețelei Wi-Fi la care trebuie să vă conectați.
După selectarea rețelei Wi-Fi la care doriți să conectați produsul, primiți mesajul „Produsul nu se poate conecta la rețea”	Verificați dacă ați introdus parola de rețea corectă. Verificați dacă rețeaua Wi-Fi pe care doriți să o conectați la produs are o conexiune la internet activă. Apăsăți butonul Încercați până când procedura este reușită. Dacă după mai multe încercări, procedura nu reușește, readuceți produsul în modul Acces Point și opriți-l timp de 1 minut. Apoi repetați procedura de la început.

Dacă apare o problemă cu modulul Wi-Fi, afișajul produsului arată un cod de eroare care vă poate ajuta să rezolvați problema:

Eroare	Descriere	Rezolvarea erorii
E01	Produsul nu se poate conecta la rețeaua Wi-Fi. Parola introdusă pentru a vă conecta la rețeaua Wi-Fi dorită (nu cea generată de produs) este incorectă sau rețeaua nu mai este disponibilă sau și-a schimbat numele.	Repetăți procedura de înregistrare conectându-vă la rețeaua Wi-Fi generată de produs și așteptați ca aplicația să afișeze din nou rețelele la care vă puteți conecta. Selectați-o pe cea dorită și introduceți din nou parola corectă.
E02	Fără conexiune internet.	Restabiliți conexiunea la Internet
E03	Serverul Radialight nu poate fi accesat.	<p>Întreținerea serverului poate fi în curs. De obicei, nu durează mai mult de câteva ore. Așteptați și verificați că eroarea nu mai este afișată și pictograma Wi-Fi a încetat să clipească.</p> <p>Dacă problema persistă, scoateți radiatorul din aplicație, restabiliți Wi-Fi-ul produsului în modul Punct de Acces și repetați întreaga procedură de înregistrare ca și cum produsul ar fi nou.</p> <p>Dacă eroarea apare după finalizarea cu succes a înregistrării, înseamnă că semnalul Wi-Fi primit de aparat este prea slab sau variabil și nu este posibilă resetarea conexiunii. În acest caz, mutați radiatorul în altă poziție sau amplificați semnalul Wi-Fi.</p>
E04	Nu a putut înregistra produsul pe serverul Radialight.	Produsul este resetat automat în modul Access Point pentru a putea repeta întreaga procedură de înregistrare de la început.
E05	Modulul Wi-Fi a fost deconectat.	<p>Opriiți produsul cu comutatorul principal timp de 1 min și apoi porniți-l din nou.</p> <p>Dacă problema persistă, încercați să o opriti timp de cel puțin o oră pentru a șterge memoria internă internă și apoi porniți-o din nou.</p>
E06	Eroare a modulului Wi-Fi.	

8. Intretinere

-Acest produs nu necesita intretinere speciala.

-Curatati produsul cu o carpa uscata odata la 6 luni.

-Daca produsul necesita reparatie, contactati un centru autorizat de service.

-Cand inlocuiti cablul de alimentare, utilizati tipul 2x1,00 mm² o 3x1,00mm² H05V2V2-F HAR. Aceasta operatiune trebuie facuta de personal autorizat si niciodata de utilizator, in acest fel evitandu-se deteriorarea aparatului si periclitarea sigurantei personale.

9. Norme legale



Mediul inconjurator si reciclarea

Pentru a contribui la protectia mediului, va cerem sa colectati in mod corect materialele utilizate pentru ambalare.

Dezmembrarea aparatelor uzate

Aparatele care poarta semnul evidentiat in partea dreapta nu trebuie aruncate impreuna cu deseurile menajere, ele trebuie colectate si dezmembrate separat. Dezmembrarea si colectarea aparatelor uzate se va face in conformitate cu legile in vigoare.

RO - Cerințe privind informațiile referitoare la aparatele electrice pentru încălzire locală

Identificatorul de model(e): KLIMA Wi-Fi					
Parametru	Simbol	Valoare	Unitate	Parametru	Unitate
Puterea termică				Modul de acumulare a căldurii, numai în cazul aparatelor electrice pentru încălzire locală cu acumulator de căldură (alegeți o variantă)	
Puterea termică nominală	P_{nom}	(*) vezi Tab. 1	kW	control manual al sarcinii termice, cu termostat integrat	nu
Puterea termică minimă (cu titlu indicativ)	P_{min}	(*) vezi Tab. 1	kW	control manual al sarcinii termice, ca răspuns la temperatura camerei și/sau exterioară	nu
Puterea termică maximă continuă	$P_{max,c}$	(*) vezi Tab. 1	kW	control electronic al sarcinii termice, ca răspuns la temperatura camerei și/sau exterioară	nu
Consumul auxiliar de energie electrică				putere termică comandată de ventilator	nu
La putere termică nominală	e_{lmax}	0,000	kW	Tip de putere termică/controlul temperaturii camerei (selectați o variantă)	
La putere termică minimă	e_{lmin}	0,000	kW	cu o singură treaptă de putere termică și fără controlul temperaturii camerei	nu
În modul standby	e_{lsb}	0,00049	kW	două sau mai multe trepte de putere manuale, fără controlul temperaturii camerei	nu
				cu controlul temperaturii camerei prin intermediul unui termostat mecanic	nu
				cu control electronic al temperaturii camerei	nu
				cu control electronic al temperaturii camerei și cu temporizator cu programare zilnică	nu
				cu control electronic al temperaturii camerei și cu temporizator cu programare săptămânală	da
				Alte opțiuni de control (se pot selecta mai multe variante)	
				controlul temperaturii camerei, cu detectarea prezenței	da
				controlul temperaturii camerei, cu detectarea unei ferestre deschise	da
				cu opțiune de control la distanță	nu
				cu demaraj adaptabil	nu
				cu limitarea timpului de funcționare	nu
				cu senzor cu bulb negru	nu
Date de contact	Ermete Giudici S.p.A. - via L. da Vinci 27 - 20090 Segrate (MI) Italia				

Tabelul 1		KLIMA 7 KLIMA 7 AS	KLIMA 10	KLIMA 15	KLIMA 20
Puterea termică					
Puterea termică nominală	P_{nom}	0,750	1,000	1,500	2,000
Puterea termică minimă (cu titlu indicativ)	P_{min}	0,075	0,113	0,150	0,188
Puterea termică maximă continuă	$P_{max,c}$	0,750	1,000	1,500	2,000

GEBRUIKSINSTRUCTIES

Lees deze instructies zorgvuldig door voordat u de radiator gebruikt. Zo voorkomt u schade en gevaarlijke situaties. Enig gebruik anders dan beschreven in deze handleiding kan brand, elektrische schokken of letsel veroorzaken en leidt ertoe dat de garantie vervalt.

De garantie geldt niet voor eventuele defecten, verslechtering, verlies, letsel of schade veroorzaakt door of als gevolg van het verkeerd gebruik of misbruik van deze radiator. Aan rechten die voortvloeien uit nationale wetgeving wordt geen afbreuk gedaan. Geen van de garantiebepalingen vormt een uitsluiting van voorwaarden of garanties vastgelegd in nationale wetgeving, die niet uitgesloten of gewijzigd kunnen worden.

Verwijder vóór het gebruik de verpakking en controleer of het apparaat intact is. Neem in geval van defecten of schade contact op met de dealer. Probeer het apparaat niet zelf te repareren.

Laat kinderen niet met de verpakking spelen en bescherm het milieu door de verpakking overeenkomstig de nationale voorschriften voor afvalverwerking te verwijderen.

1. Voor uw veiligheid

- ❑ Dit apparaat is bedoeld voor normaal huishoudelijk gebruik en niet voor gebruik in voertuigen of aan boord van schepen of vliegtuigen.
- ❑ Dit apparaat kan worden gebruikt door kinderen vanaf 8 jaar en personen met verminderde lichamelijke, zintuiglijke of verstandelijke vermogens of een gebrek aan ervaring en kennis, mits ze onder toezicht staan of instructies hebben gekregen over hoe ze het apparaat op een veilige manier kunnen gebruiken en de risico's begrijpen. Kinderen mogen niet met het apparaat spelen. Reiniging of onderhoud mag niet door kinderen worden uitgevoerd, tenzij onder toezicht.
- ❑ Kinderen jonger dan 3 jaar moeten uit de buurt van het apparaat worden gehouden, tenzij er voortdurend toezicht is.
- ❑ Kinderen tussen de 3 en 8 jaar mogen het apparaat alleen in-/uitschakelen indien het op de beoogde, normale plek van gebruik is geplaatst of geïnstalleerd, mits ze onder toezicht staan of instructies hebben gekregen over hoe ze het apparaat op een veilige manier kunnen gebruiken en de risico's begrijpen. Kinderen tussen de 3 en 8 jaar mogen het apparaat niet aansluiten, regelen of schoonmaken, of onderhoud eraan plegen.
- ❑ **LET OP: Sommige delen van dit apparaat kunnen zeer heet worden en brandwonden veroorzaken. Let vooral op wanneer kinderen en kwetsbare personen aanwezig zijn.**
- ❑ Zorg ervoor dat de netvoeding overeenkomt met de nominale voedingsspanning: 230 V AC, 50 Hz.
- ❑ Laat kinderen niet met het apparaat spelen en zorg ervoor dat kinderen en dieren het niet aanraken. Let op! Het paneel kan tijdens gebruik zeer heet worden (circa 80 °C);

- ❑ **WAARSCHUWING: Om oververhitting te voorkomen, mag de radiator niet worden bedekt.** Hang geen voorwerpen over de radiator en bedek het apparaat niet terwijl het in gebruik is. Dit wordt duidelijk op het apparaat vermeld of aangegeven door het symbool



- ❑ Gebruik het apparaat niet in ruimtes met explosieve gassen, dampen van oplosmiddelen of verf, of ontvlambare dampen/gassen.
- ❑ Repareer een beschadigde kabel en/of stekker niet zelf, maar breng het apparaat naar de technische dienst of een erkend reparatiecentrum en laat het repareren door gespecialiseerd personeel om het risico op beschadiging te voorkomen.
- ❑ Plaats het apparaat zodanig dat de stekker altijd bereikbaar is.
- ❑ Het apparaat mag niet direct onder een stopcontact worden geplaatst.
- ❑ Steek geen objecten of papier in de radiator.

2. Het product

- ❑ Naast de door u gekozen radiator bevat het pakket het volgende (afbeelding 1):
 - N° 1 metalen beugel voor wandmontage (bevestigd aan de radiator);
 - N° 4 nylon muurplugs 8 x 50 mm;
 - N° 4 kruiskopschroeven 5 x 60 mm voor bevestigen van muurbeugel;
- ❑ Neem contact op met uw dealer als iets kapot is of ontbreekt.

3. Veilige positionering

- ❑ Gebruik het apparaat alleen in de horizontale positie;
- ❑ Het beschikt over een dubbele elektrische isolatie (klasse II) en heeft daarom geen aardverbinding nodig;
- ❑ Neem de minimumafstanden tot muren, meubels en/of objecten in acht (zie afbeelding 2).
- ❑ Installeer het apparaat niet op een oppervlak van hout of synthetisch materiaal.
- ❑ Het apparaat is waterbestendig (IP24). Het kan daarom in badkamers of andere vochtige ruimtes worden gebruikt, mits het niet in de zone van badkuipen of douches wordt geïnstalleerd (volume 1, afbeelding 3).
- ❑ Installeer de radiator niet op een tochtige plek; dit kan de regeling beïnvloeden.

4. Installatie

- ❑ Verwijder de wandmontagebeugel aan de achterkant van de radiator door eerst de 2 bovenste veren en vervolgens de 2 onderste veren (zie afb. 4) in te drukken.
- ❑ Plaats de beugel op de vloer en gebruik hem als sjabloon om de plek te markeren waar de twee onderste bevestigingsgaten gemaakt moeten worden (afb. 5A).
- ❑ Til de beugel op totdat de onderste bevestigingspunten overeenkomen met de gemaakte markeringen en gebruik een potlood om de plek van de twee bovenste bevestigingsgaten te markeren (afb. 5B).
- ❑ Boor de 4 gaten op de gemarkeerde plekken en steek de muurpluggen in (afb. 6).
- ❑ Bevestig de beugel aan de muur met behulp van de 4 meegeleverde schroeven (afb. 7).
- ❑ Hang de radiator op de beugel, beginnende met de 2 onderste bevestigingspunten, en klik vervolgens de 2 bovenste bevestigingspunten in positie (afb. 8).
- ❑ Indien de radiator op een later tijdstip van de beugel moet worden gehaald, bevelen wij aan eerst de onderste twee bevestigingspunten los te klikken en daarna de bovenste.

5. Elektrische aansluitingen

- ❑ Het apparaat moet worden gevoed met een spanning van 230 V AC, 50 Hz.
- ❑ Het apparaat moet met een kabel en stekker of met een installatiekabel worden geleverd. Indien een apparaat met stekker in Frankrijk wordt geïnstalleerd, dient de stekker te worden afgesneden en het apparaat via een geschikte aansluitdoos op de netvoeding te worden aangesloten.

- ❑ Als het apparaat met een aansluitkabel zonder stekker wordt geleverd, moet het via een 3-aderige kabel (bruin = fase draad, blauw = nuldraad, zwart = schakeldraad) en een aansluitdoos op de netvoeding worden aangesloten. **Als u de schakeldraadfuncties niet wilt gebruiken, sluit u alleen de fase- en nuldraad aan: voor het correct functioneren van het apparaat is de externe programmeringsunit niet vereist.**
- ❑ Installeer de aansluitterminal in badkamers, keukens of andere vochtige ruimtes ten minste 25 cm boven de vloer.
- ❑ De elektrische aansluiting op de netvoeding moet tevens een 2-polige schakelaar met een minimale contactopening van 3 mm omvatten. Leef altijd de nationale bekabelingsvoorschriften na.
- ❑ Het apparaat mag niet op de aarddraad worden aangesloten. **SLUIT DE SCHAKELDRAAD (ZWART) NIET AAN OP DE AARDDRAAD.**
- ❑ Als het apparaat via een differentieelschakelaar (30 mA) wordt gevoed, moet u ervoor zorgen dat de schakeldraad ook op de differentieelschakelaar is aangesloten.

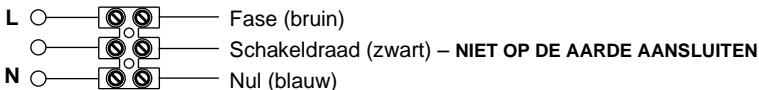

6. Het apparaat gebruiken

6.1 Beschrijving van de knoppen

- A – Aan-uitknop/standby
- B – Modusknop
- C – Speciale functies
- D – Verhogen/activeren
- E – Verlagen/deactiveren
- F – Display
- G – Hoofdschakelaar

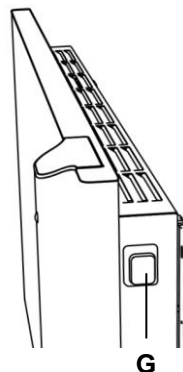
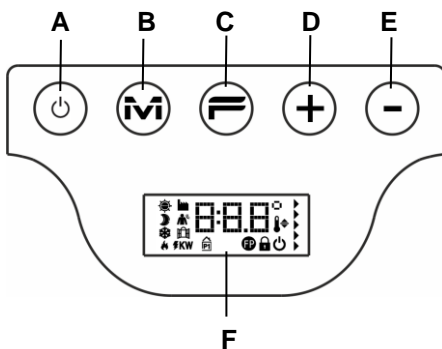

6.2 Bediening

6.2.1 Het display inschakelen

Indien het display niet ingeschakeld is, moet u op een knop drukken om het op te laten lichten.
 Het display licht op en blijft 30 seconden geactiveerd nadat voor het laatst een knop is ingedrukt.







Als het display uitgeschakeld is, licht het de eerste keer dat een knop is ingedrukt op zonder de functie van de desbetreffende knop te activeren.

6.2.2 De radiator in-/uitschakelen

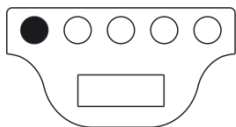

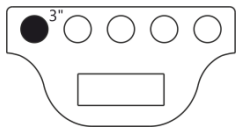

De stroomtoevoer naar de radiator wordt geregeld middels een 2-polige elektromechanische schakelaar (G) aan de rechterzijde van de radiator. Als deze schakelaar wordt gebruikt, wordt de stroomtoevoer naar de printplaat ook uitgeschakeld. Als gevolg hiervan gaan na circa 30 minuten alle opgeslagen parameters verloren en worden de standaardinstellingen teruggezet.

Wij raden aan deze schakelaar alleen te gebruiken als de radiator lange tijd niet zal worden gebruikt. Druk op de Aan-uit-/standby-knop (A) om de radiator korte periodes uit te schakelen. Zo voorkomt u dat de instellingen verloren gaan.







<p>Als de radiator door middel van de hoofdschakelaar aan de zijkant wordt ingeschakeld, licht het display op en wordt het standby-symbool weergegeven.</p>		
<p>Druk voor het inschakelen van de radiator op de Aan-uit-/standby-knop.</p> 		<p>De radiator begint altijd in de comfort-modus. Indien de radiator nieuw is of de stroomtoevoer langer dan 30 minuten is uitgeschakeld, staat de comforttemperatuur op de standaardwaarde (19 °C).</p>
<p>Om de radiator uit te uitschakelen, moet u de Aan-uit-/standby-knop ten minste 3 seconden ingedrukt houden.</p> 		<p>Als u de radiator uitschakelt met de schakelaar aan de zijkant, gaan na 30 minuten alle opgeslagen gegevens verloren (datum, tijd, temperatuurstellingen, etc.).</p>

6.2.3 De modus kiezen

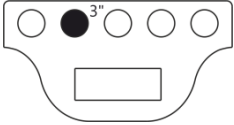
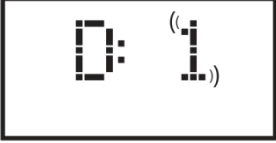
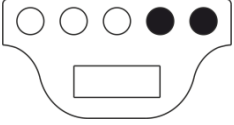
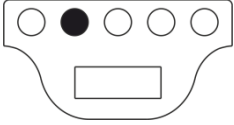
<p>Door herhaaldelijk op de "M"-knop te drukken, kunt u de gewenste modus kiezen.</p> 		<p>De modi worden in de volgende volgorde geactiveerd:</p>  <p>Dertig seconden nadat de "M"-knop is ingedrukt, begint de activeringsvolgorde van de modi weer vanaf het begin, zodat vanuit een willekeurige modus sneller naar de Comfort-modus kan worden geschakeld.</p>
---	---	---

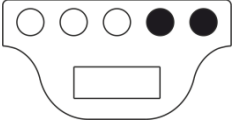
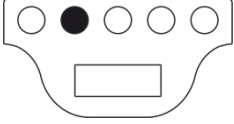
Icoontje	Beschrijving	Wanneer gebruikt
	Comfort	Als u thuis bent. De radiator handhaaft de ingestelde temperatuur.
	Eco	Als u korte tijd van huis bent (van 2 tot 48 uur) of als u slaapt. De radiator handhaaft de ingestelde eco-temperatuur en bespaart energie.
	Antivorst	Als u lange tijd van huis bent (meer dan 48 uur). De temperatuur wordt automatisch ingesteld op 7±3 °C en kan niet worden veranderd.
	Programma P1	Als u vooraf ingestelde programma's wilt, geschikt voor diegenen die niet thuis werken. DIT PROGRAMMA KAN TEVENS WORDEN AANGEPAST (ZIE DE INSTRUCTIES IN PARAGRAAF 6.2.6.).
	Schakeldraad	Als u de werking van de radiator controleert aan de hand van een externe regelunit met een schakeldraad.

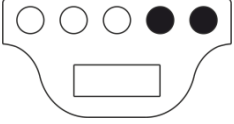
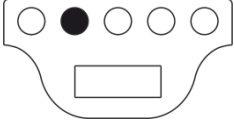
6.2.5 De dag en tijd instellen

<p>De dag en tijd worden ingesteld om gebruik te kunnen maken van de drie vooraf ingestelde programma's. Houd hiervoor de modusknop ingedrukt.</p> 		<p>De in te stellen dag begint te knipperen (1 = maandag). Druk op de "+"- of "-"-knop om deze te wijzigen.</p> 
<p>Druk op de modusknop om de dag te bevestigen en verder te gaan naar het instellen van de tijd.</p> 		<p>Op het display begint de uurwaarde te knipperen. Druk op de "+"- of "-"-knop om deze te wijzigen.</p> 
<p>Druk op de modusknop om de uurwaarde te bevestigen en verder te gaan naar het instellen van de minuten.</p> 		<p>Op het display beginnen de minuten te knipperen. Druk op de "+"- of "-"-knop om deze te wijzigen.</p> 
<p>Druk op de modusknop om de minuten te bevestigen en het instellen te beëindigen.</p> 		<p>Het systeem keert terug naar de modus die geactiveerd was voordat u met instellen begon.</p> <p>Als u probeert een vooraf ingesteld programma te activeren zonder dat u de datum en tijd heeft opgeslagen, wordt deze instellingsprocedure automatisch geactiveerd.</p>



6.2.6 Programma P1 wijzigen







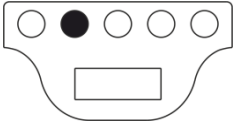

Het programma P1 kan aan de behoeften van gebruikers worden aangepast. Door P1 te wijzigen, kunt u de gewenste kamertemperatuur, instellen, waarbij u keuze heeft uit Comfort, ECO of Vorstvrij, voor elk uur van de dag en voor de hele week.

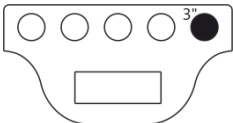
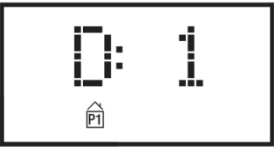
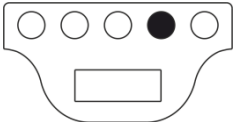

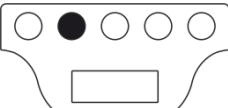
Zie paragraaf 6.2.4 voor het instellen van de temperaturen voor elke modus.

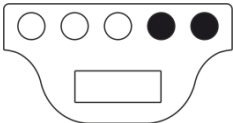
Elk weergegeven uur van de dag toont de momenteel ingestelde temperatuur van programma P1. Indien de radiator voor het eerst wordt gebruikt, verwijzen wij u naar paragraaf 6.2.3.1 voor het ingestelde profiel van P1.

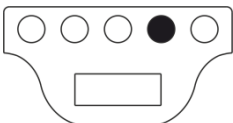
Als u programma P1 wilt weergeven of wijzigen, moet u het volgende doen:

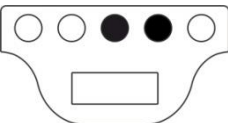

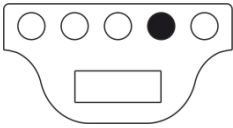

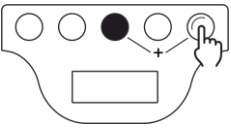
<p>Druk op "M" om programma P1 te kiezen.</p> 		<p>Indien de tijd nog niet is ingesteld (nieuw product, of langer dan 30 min. geen stroomtoevoer), wordt de procedure voor het instellen van de tijd automatisch geactiveerd (zie paragraaf 6.2.5)</p>
---	---	--





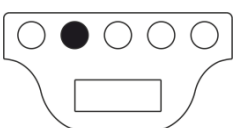

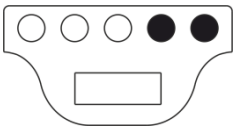
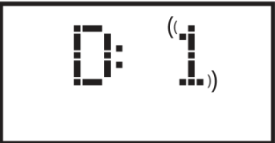
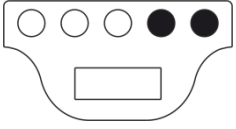



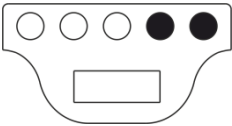

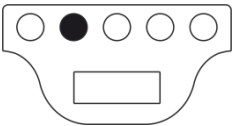

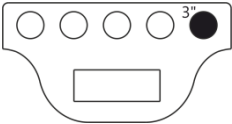

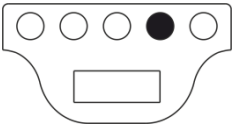

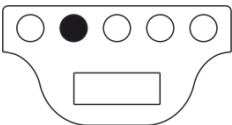
<p>Houd de “-”-knop 3 seconden ingedrukt om programma P1 op te roepen.</p> 		<p>De eerste weer te geven/aan te passen dag wordt nu getoond (1 = maandag)</p>
<p>Druk op de “+”-knop om het eerste weer te geven/aan te passen uur in te stellen.</p> 		<p>Druk op de “M”-knop om de gewenste temperatuur te kiezen (keuze uit Comfort, Eco of Vorstvrij):</p>   <p>De temperatuur die wordt weergegeven nadat u een specifiek uur heeft gekozen, is de temperatuur die momenteel voor programma P1 is ingesteld.</p>
<p>Gebruik de “+”- en “-”-knoppen om elk uur van dag 1 in te stellen en de temperatuur voor elk uur te zien/te wijzigen.</p> 		<p>Het weergegeven uur duidt altijd op het startpunt. Bijvoorbeeld: als H 23 wordt weergegeven, heeft de wijziging betrekking op de periode tussen 23.00 en 0.00.</p>
<p>Indien u de temperatuur voor elk van de 23 uren van Dag 1 heeft aangepast, drukt u op de “+”-knop om naar de wijzigingsmodus voor Dag 2 te gaan.</p> 		<p>Druk op de “+”-knop om de temperatuur voor elk uur van Dag 2 weer te geven/aan te passen, zoals beschreven voor Dag 1. U kunt het programma van Dag 1 automatisch voor Dag 2 gebruiken door de “F”-knop ingedrukt te houden en op de “+”-knop te drukken.</p>  <p>Opmerking: u mag hetzelfde dagprogramma ALLEEN kopiëren en plakken WANNEER het cijfer van de dag die u wilt wijzigen, wordt weergegeven (zie afbeelding) - EN NIET wanneer het uur wordt weergegeven.</p>

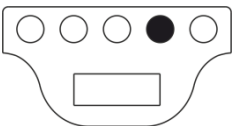
<p>Als de laatste dag (Dag 7) is ingesteld, drukt u op de "+"-knop om de programmeerprocedure te beëindigen.</p> 		<p>END verschijnt op het display. Door nog een keer op de "+"-knop te drukken, bevestigt u het gewijzigde programma.</p>
<p>"OK" verschijnt gedurende 5 seconden op het display, als bevestiging dat de programmeerprocedure succesvol is uitgevoerd. Het systeem is nu ingesteld om de temperatuur aan te passen overeenkomstig het gewijzigde programma P1.</p>		<p>Opmerking: u kunt de programmeerprocedure op elk moment verlaten, zonder elk uur tot Dag 7 weer te geven. Houd hiervoor de "F"-knop indrukt en druk op de "-"-knop.</p> 
<p>N.B.:</p> <ul style="list-style-type: none"> - U kunt de display-/wijzigingsprocedure op elk moment afbreken door op de "Standby"-knop te drukken. Alle niet-opgeslagen instellingen worden dan verwijderd. - Het herstellen van de standaardinstellingen leidt ertoe dat elk eerder aangemaakt P1-programma wordt verwijderd (zie paragraaf 6.3); - Indien tijdens het instellen van het programma 90 seconden lang geen knop wordt ingedrukt, wordt de display-/wijzigingsprocedure afgebroken en worden de standaard fabrieksinstellingen hersteld; - De verwarmingselementen worden tijdens de programmeerprocedure automatisch in de standby-modus geschakeld. De radiator verwarmt dan niet. 		

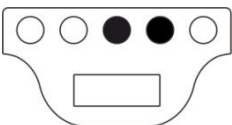
VOORBEELD: EEN AANGEPAST PROGRAMMA INSTELLEN

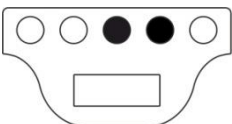
In het onderstaande wordt beschreven hoe u een nieuwe radiator kunt programmeren, en 1 uur eerder op de verandering van ECO- naar COMFORT-temperatuur kunt anticiperen (06.00 uur is de standaard fabrieksinstelling), voor elke dag van maandag tot vrijdag.

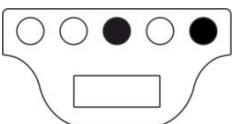
<p>Druk op "M" om programma P1 te selecteren</p>		
<p>Stel de huidige dag van de week in (eerste gebruik van de radiator) met de "+"- of "-"-knop.</p>		
<p>Druk op "M" en stel het huidige uur in (eerste gebruik van de radiator) met de "+"- of "-"-knop.</p>		

<p>Druk op "M" en stel de huidige minuten in (eerste gebruik van de radiator) met de "+"- of "-"-knop.</p>		
<p>Druk op "M" om de tijdstellingsprocedure te beëindigen. Het systeem keert nu terug naar programma P1.</p>		
<p>Houd "-" 3 seconden ingedrukt om Dag 1 weer te geven/aan te passen.</p>		
<p>Houd "+" ingedrukt totdat u H:05 op het display ziet (het uur waarvoor we de ECO-temperatuur in COMFORT willen veranderen).</p>		
<p>Druk twee keer op "M" om de ECO-temperatuur te veranderen in COMFORT.</p>		
<p>Houd "+" ingedrukt totdat D:2 op het display verschijnt (dinsdag)</p>		
<p>Om hetzelfde programma van Dag 1 naar Dag 2 te kopiëren en te plakken, houdt u "F" ingedrukt en drukt u op "+". Het systeem kopieert het programma automatisch en geeft direct Dag 3 (woensdag) weer.</p>		
<p>Herhaal de eerder beschreven procedure totdat D:6 op het display verschijnt.</p>		
<p>Aangezien we Dag 6 en 7 niet willen aanpassen, kunnen we de modus Programma-instellingen verlaten. Houd hiervoor "F" ingedrukt en druk op "-". "END" verschijnt op het display.</p>		

Druk op “+” om de wijzigingen te bevestigen.
“OK” knippert gedurende 5 sec. op het display.

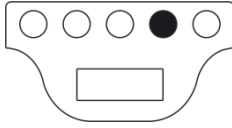

6.3 Speciale functies

Door herhaaldelijk op de “F”-knop te drukken, kunt u de verschillende speciale functies in volgorde selecteren.

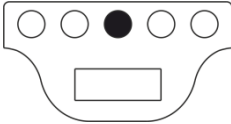

Om het menu voor speciale functies te verlaten, wacht u 12 seconden of drukt u op de “M”-knop om terug te gaan naar de geactiveerde modus.

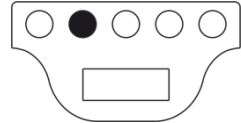

De standaardinstellingen herstellen

Let op:
Een instelling van een wiferverbinding die eerder is opgeslagen, wordt NIET door het terugzetten van de fabrieksinstellingen geannuleerd.



Als u de standaardinstellingen (door de fabrikant ingesteld) van de radiator wilt herstellen, moet u de “+”-knop ten minste 3 seconden ingedrukt houden.

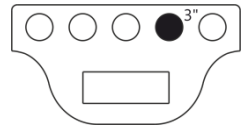

Wi-Fi

Dankzij deze functie is het mogelijk om de radiator door middel van internettoegang met uw wifinetwerk te verbinden en met de app te bedienen.

Zie voor meer informatie paragraaf 6.3.3.



Deze functie kan worden ingeschakeld (ON) of uitgeschakeld (OFF) door respectievelijk op '+' of '-' te drukken.

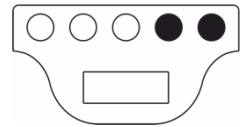

Inschakeling wordt aangegeven door het betreffende icoontje dat op het display gaat branden. 

Aanwezigheidssensor

Als deze functie geactiveerd is, kan de radiator eventuele personen in de ruimte detecteren. De temperatuur wordt automatisch aangepast om comfort en energiebesparing te optimaliseren.







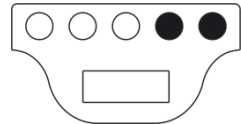

Zie paragraaf 6.3.1 voor meer informatie.

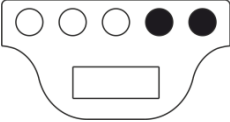

U kunt deze functie inschakelen (ON) of uitschakelen (OFF) door op de “+”- respectievelijk “-”-knop te drukken.



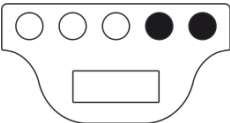

Activering wordt aangeduid door het relevante icoontje  dat op het display verschijnt

<p>Raam open-sensor</p> <p>Deze functie maakt het mogelijk een open raam te detecteren en automatisch de antivorst-modus te activeren.</p> <p>Zie paragraaf 6.3.2 voor meer informatie.</p>		<p>U kunt deze functie inschakelen (ON) of uitschakelen (OFF) door op de "+"-respectievelijk "-"-knop te drukken.</p>  <p>Activering wordt aangeduid door het relevante icoontje  dat op het display verschijnt.</p>
<p>Dagelijks verbruik</p> <p>Deze functie maakt het mogelijk om te zien hoeveel energie de radiator de afgelopen 24 uur heeft verbruikt.</p>		<p>Als de verbruiksindicatie knippert, betekent dit dat de opgeslagen gegevens betrekking hebben op een periode korter dan 24 uur.</p> <p>Let op: Het display toont het geschatte verbruik, dat af kan wijken van het verbruik gemeten door meters die specifiek daarvoor bedoeld zijn.</p>
<p>Wekelijks verbruik</p> <p>Deze functie maakt het mogelijk om te zien hoeveel energie de radiator de afgelopen 7 dagen heeft verbruikt.</p>		<p>Als de verbruiksindicatie knippert, betekent dit dat de opgeslagen gegevens betrekking hebben op een periode korter dan 7 dagen.</p> <p>Let op: Het display toont het geschatte verbruik, dat af kan wijken van het verbruik gemeten door meters die specifiek daarvoor bedoeld zijn.</p>
<p>De kamertemperatuur weergeven</p>		<p>Het display toont de kamertemperatuur die door de radiator is gemeten.</p>
<p>De kamertemperatuur corrigeren</p> <p>Deze functie wordt gebruikt om de door de radiator gemeten kamertemperatuur aan te passen en het verwarmingsvermogen te regelen, om te compenseren voor leesfouten door o.a. de nabijheid tot warmtebronnen of koude luchtstromen.</p>		<p>Op het display knippert de correctiewaarde die moet worden toegepast. Druk op de "+"- of "-"-knop om deze te wijzigen.</p>  <p>Als de op de radiator ingestelde temperatuur bijvoorbeeld 19,2 °C is en de gemeten kamertemperatuur 19,5 °C, is de correctiewaarde +0,3 °C.</p> <p> Wacht ten minste 4 uur om de temperatuur te laten stabiliseren voordat u een correctie uitvoert.</p>

6.3.1 Aanwezigheidssensor

Als deze functie geactiveerd is, kan de radiator eventuele personen in de ruimte detecteren. De temperatuur wordt automatisch aangepast om comfort en energiebesparing te optimaliseren.

Deze functie, die alleen in de Comfort-modus kan worden geactiveerd, stelt de radiator in staat voortdurend de ruimte te bewaken. Indien geen personen worden gedetecteerd, wordt de ingestelde comforttemperatuur als volgt verlaagd:

Afwezigheids-duur	Verlaging van comfort-temperatuur	Indicatie op het display
60 min.	1,0 °C	De icoontjes voor de aanwezigheidssensor en comfort-modus knipperen allebei  (())
90 min.	2,0 °C	
120 min.	3,5 °C	
38 uur	Antivorst geactiveerd 7 ± 3 °C	

De temperatuurverlaging heeft altijd betrekking op de comforttemperatuur. Indien de Eco- of Antivorst-modus van de radiator geactiveerd is, wordt de temperatuur in de ruimte niet aangepast.

Als een persoon ten minste 10 opeenvolgende minuten in de ruimte wordt gedetecteerd, wordt de temperatuur automatisch verhoogd naar de comforttemperatuur, zonder enige reductie. Hetzelfde gebeurt als op de "M"-knop wordt gedrukt terwijl de gewenste temperatuur wordt verlaagd omdat er geen personen in de ruimte worden gedetecteerd.

Belangrijk:

De correcte werking van deze functie is afhankelijk van de plek waar de radiator in de ruimte geïnstalleerd is. Bij het kiezen van de beste installatiepositie dient u er rekening mee te houden dat de sensor bewegingen detecteert binnen de zone weergegeven in afb. 9. Er mogen geen objecten voor de sensor staan die de detectie belemmeren. Aanwezigheidsdetectie is bovendien effectiever wanneer personen voor de sensor langs lopen in plaats van ernaartoe.

6.3.2 Raam open-sensor

Deze functie maakt het mogelijk een open raam te detecteren en automatisch de antivorst-modus te activeren.

Indien een plotselinge verlaging van de temperatuur wordt gedetecteerd wanneer de radiator normaal functioneert, wordt de antivorst-modus automatisch geactiveerd om energieverstopping te beperken. Op het display knippert zowel het raam- als antivorst-icoontje, terwijl het icoontje voor de modus ingesteld door de gebruiker zichtbaar blijft.

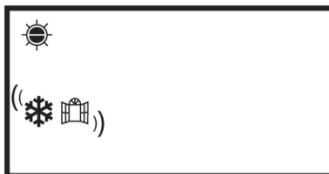

De normale modus wordt niet automatisch hersteld; druk op de "M"-knop om deze te activeren.





Belangrijk:

De correcte werking van deze functie is afhankelijk van de plek waar de radiator in de ruimte geïnstalleerd is, de aanwezigheid van tocht, de buitentemperatuur en hoe lang het raam open blijft.

6.3.3 Gebruik van de app

Dankzij deze functie is het mogelijk om de radiator door middel van internettoegang met een wifinetwerk te verbinden en met de speciale Radialight®-app te bedienen.

Volg de instructies die direct in de app worden getoond of lees de gedetailleerde handleiding die de procedure stap voor stap weergeeft, om het product met het wifinetwerk te verbinden. Kies de handleiding voor uw besturingssysteem:

	android	Apple iOS
DOWNLOAD DE APP	 www.radialight.com/app-android	 www.radialight.com/app-ios
OPEN DE SNELSTARTGIDS	 www.radialight.com/android-start-guide	 www.radialight.com/ios-start-guide

Zodra de verbinding tot stand is gebracht, wordt de volgende startpagina op de app weergegeven:

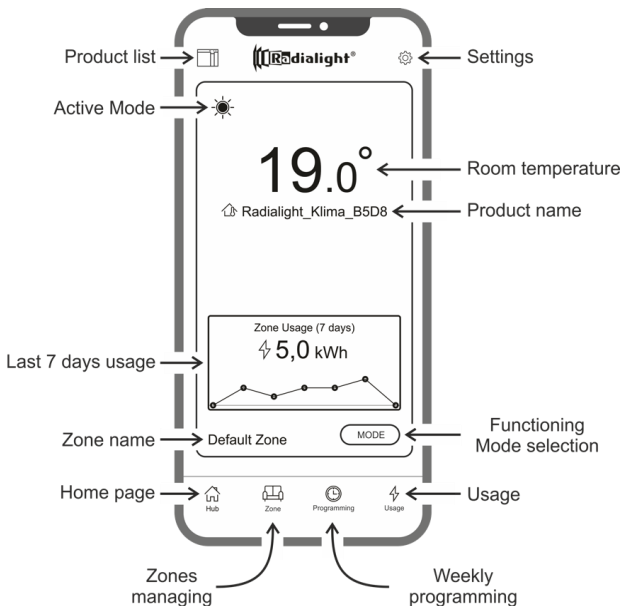

Product list: hiermee kunt u de lijst met alle geregistreerde producten zien en nieuwe toevoegen. Voor elk product worden de huidige actieve bedrijfsstand, de naam van de zone van het product en de indicator van verwarming weergegeven. Met verdere opties kunt u de betreffende zone en de productnaam wijzigen en het product uitschakelen. Door het producticoontje van rechts naar links te slepen, vindt u een knop waarmee u het product kunt verwijderen en uit de productenlijst wissen.

Active Mode: een icoontje met hetzelfde symbool als op het display van het product geeft de actieve stand weer. Als de geprogrammeerde stand actief is, staat naast het klok-symbool het icoontje van de geplande bedrijfsstand. De naam van het actieve programma wordt rechts van dit symbool ook weergegeven.

Last 7 days usage: Het energieverbruik van de afgelopen 7 dagen wordt weergegeven en de trend in het verbruik wordt voor elke dag grafisch afgebeeld. Door op de grafiek te drukken komt u in het deel met de verbruiksanalyse.

Zone name: het geeft de naam aan die aan de zone is toegewezen en dit kan speciaal worden aangepast door onderstaande instructies te volgen.

Zones managing: hiermee kunt u de lijst met gedefinieerde zones bekijken en deze verwijderen of nieuwe aanmaken. Voor elke zone wordt de naam en actieve stand weergegeven en er is een toets beschikbaar waarmee de bedrijfsstand van alle producten in de zone kunnen worden gewijzigd.

Weekly programming: door op dit icoontje te drukken opent u het onderdeel voor het weekprogramma. In dit deel is het mogelijk om het standaard vooraf ingestelde programma te wijzigen of nieuwe aan te maken. Elk programma kan worden voorzien van een speciale naam en kleur, zodat deze gemakkelijker te herkennen zijn. Annuleren van een programma kan worden uitgevoerd door het programma-icoontje van rechts naar links te slepen.

Usage: door op dit icoontje te drukken, kunt u het onderdeel gebruiksanalyse openen en de op een dagelijkse, wekelijkse of maandelijkse basis opgeslagen gegevens bekijken, opgesplitst naar gebied of gebundeld.

Functioning Mode selection: hiermee kunt u de bedrijfsstand selecteren met keuze uit Comfort, Eco, Vorstvrij, Geprogrammeerd, Communicatie en Stand-by. Indien gewenst kan deze afwisseling worden ingesteld: aan het einde van de ingestelde tijd keert de actieve stand terug naar de stand die voor de wijziging was ingesteld.

Product name: de productnaam wordt in het midden van het display weergegeven. Als er in een zone meerdere producten zijn, wordt de relevante informatie (naam en ruimtetemperatuur) achtereenvolgens weergegeven.

Room temperature: de door de productsensor gemeten temperatuur wordt weergegeven.

Settings: in dit onderdeel kunt u:

- De handleiding bekijken met uitleg over hoe de app werkt;
- De kostenbewaking inschakelen waarbij aan de waarde van een kWh ook een economische waarde kan worden toegekend door de kosten per energie-eenheid te specificeren;
- De gebruiksmeldingen beheren als de sensor voor een open raam is ingeschakeld en deze actief wordt;
- De gebruiksmeldingen beheren als een of meerdere producten in de stand-bystand staan terwijl de zone waartoe ze behoren in een andere stand staat;
- De gebruiksmeldingen beheren als een ingestelde verbruiks- of kostengrens wordt overschreden;
- Het wachtwoord van het account wijzigen;
- De instemming met het ontvangen van updates en aanbiedingen wijzigen.

Door in het midden van de zone te drukken, kunt u de weergave van de gedetailleerde zone-instellingen openen:

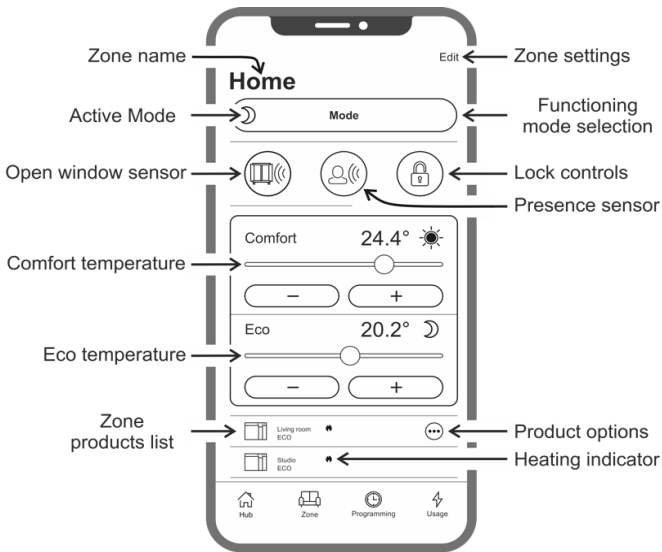

Open window sensor: hiermee kunt u de detectie voor het openen van een raam (zie paragraaf 6.3.2) in- of uitschakelen.

Presence sensor: hiermee kunt u de functie voor vermindering van de comforttemperatuur in- of uitschakelen als de ruimte voor een bepaalde tijd niet bezet is (zie paragraaf 6.3.1).

Lock controls: hiermee kunt u de bedieningstoetsen op het product vergrendelen, zodat toevallige of onbevoegde wijzigingen worden voorkomen (zie paragraaf 6.4).

Zone products list: alle producten die tot de geselecteerde zone behoren worden onderaan het scherm vermeld. Elk product met zijn naam, de actieve bedrijfsstand en de verwarmingsstatus.

Heating indicator: het icoontje brandt als de ruimtetemperatuur lager dan gewenst is en het product werkt om de ruimte te verwarmen.

Product options: hiermee kunt u de toegewezen zone en de productnaam wijzigen of het product uitschakelen.

Zone products list: hiermee kunt u de naam en de achtergrondafbeelding van de zone wijzigen.

Tegenstrijdigheden

Als een zone 2 of meer producten bevat en één of meerdere hebben een verschillende instelling dan de instelling voor de zone, dan treedt een tegenstrijdigheid op.

Deze situatie die meestal te wijten is aan een handmatige aanpassing van een productparameter, kan betrekking hebben op een bedrijfsstand, de sensorstatus of de waarden van de Comfort- en Eco-temperatuur.

Als deze toestand optreedt, geeft de app de tegenstrijdige zoneparameter aan door, zoals aangegeven in de afbeelding rechts, een speciaal symbool weer te geven.

Hetzelfde symbool verschijnt in de linker bovenhoek van het productieontje dat in de lijst aan de onderkant van het scherm wordt weergegeven. Op deze wijze wordt de gebruiker geïnformeerd over het product dat ervoor zorgt dat een of meerdere instellingen niet overeenkomen met degene die voor de zone zijn gedefinieerd.

Door op het symbool van de tegenstrijdigheid te drukken, is het mogelijk om alle producten te resetten naar de parameters die hiervoor voor de zone waren ingesteld.

Als de aanpassing van de instellingen van een of meerdere van de producten de bedoeling was, is het mogelijk om de symbolen die worden weergegeven, te negeren. Als echter het gebruik van verschillende instellingen vaker voorkomt, is het aan te raden om de producten aan verschillende zones toe te wijzen, zodat ze kunnen worden beheerd zonder voortdurende weergave van de tegenstrijdigheidssymbolen.

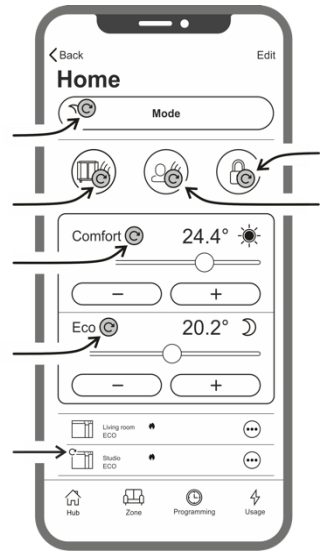

Het is goed om te weten dat:

Tijdmanagement

De instelling van de huidige tijd en dag van de week wordt bij de eerste registratie naar de radiator verzonden. Tegelijkertijd wordt de tijdzone van het gebied waar het product is geïnstalleerd, opgeslagen.

Het gebruik van zomertijd gebeurt niet automatisch, maar het is voldoende om na de wisseling van de tijd een willekeurig signaal naar de zone te sturen, zodat de producten die tot de zone behoren, naar de juiste tijd worden gereset.

Stroomstoring

Als de stroomvoorziening meer dan 30 minuten is uitgeschakeld, raakt de radiator veel van zijn interne instelling kwijt. Zodra de stroom weer is ingeschakeld, maakt het product automatisch weer verbinding met het wifinetwerk en stelt de stand-bystand in. Het is daarom aan te bevelen om de details van het gebied te controleren of de stand die op de app is ingesteld overeenkomt met de stand van het product. In het onderdeel instellingen is het mogelijk om een melding naar de gebruiker te sturen als er producten in de stand-bystand worden gedetecteerd, terwijl de zone waartoe ze behoren in een andere stand staat.

Meldingen









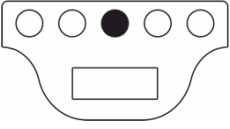

In het onderdeel instellingen kunt u definiëren of u bij speciale gebeurtenissen al dan niet meldingen wil ontvangen. Als meldingen bij installatie van de app zijn toegestaan worden deze weergegeven hetzij met de app geopend of afgesloten. Zie de instructies van het besturingssysteem van uw smartphone om de activering van meldingen te controleren.

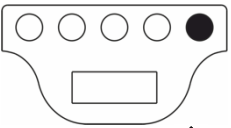
Sterkte wifisignaal

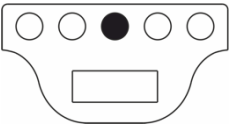
Als de radiator in een gebied is geïnstalleerd waar het signaal van uw wifinetwerk zwak is, kunt u mogelijk een bepaalde vertraging merken in de uitvoering van commando's die via de app zijn verzonden of zelfs een tijdelijke onderbreking van de communicatie. Om dit probleem op te lossen, moet de sterkte van het signaal in het installatiegebied worden verhoogd.

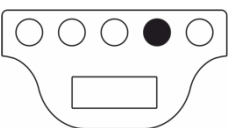
Beheer van de wifimodule:

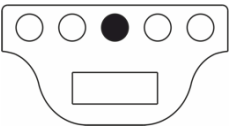
De wifimodule kan conform uw wensen worden ingeschakeld, uitgeschakeld of in de stand Access Point aangegeven zijn.

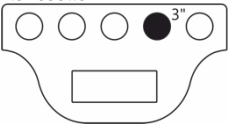
<p>Druk, om de wifimodule uit te schakelen, op de 'F'-toets totdat het woord wifi op het display verschijnt.</p> 		<p>Druk op de '-' toets om de module uit te schakelen.</p>  <p>De uitschakeling van het  icoontje bevestigt de juiste uitvoering van het commando.</p>
<p>Druk, om de wifimodule in te schakelen, op de 'F'-toets totdat het woord wifi op het display verschijnt.</p> 		<p>Druk op de '+' toets om de module in te schakelen.</p>  <p>De inschakeling van het  icoontje bevestigt de juiste uitvoering van het commando.</p>
<p>Druk op de 'F'-toets totdat het woord wifi op het display verschijnt, om de wifimodule terug te zetten naar de stand Access Point, gereed om verbinding te maken met een wifinetwork.</p> 		<p>Druk 3 sec. lang op de '+' toets om de module te resetten.</p>  <p>Weergave van het woord 'AP' bevestigt de terugkeer naar de stand Access Point.</p>





De status van de wifimodule wordt op het display door een klein icoontje aan de rechterzijde weergegeven.

<p>WIFI AAN en MET EEN GELDIG NETWORK VERBONDEN</p>	<p>licht van het symbool brandt</p>	
<p>WIFI AAN maar NIET MET EEN GELDIG NETWORK VERBONDEN of VERBONDEN MET EEN NETWORK ZONDER INTERNET</p>	<p>symbool knippert</p>	
<p>WIFI AAN en klaar voor de eerste configuratie</p>	<p>symbool knippert</p>	
<p>WIFI UIT</p>	<p>symbool onzichtbaar</p>	

Let op: na inschakeling van het product is voor de verbinding met het wifinetwork en de app een wachttijd van tenminste 30 seconden vereist. Als dit niet werkt, knippert het wifisymbool en op de app wordt aangegeven dat het product niet is verbonden. In dat geval moet de radiator tenminste 30 seconden worden uitgeschakeld voordat het opnieuw kan worden geprobeerd.

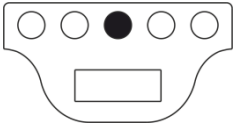
Zie paragraaf 7 voor oplossing van de meest voorkomende problemen en de uitleg van de foutcodes.

6.4. Aanvullende mogelijkheden

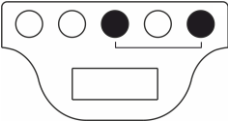
<p>Knoppen vergrendelen</p> <p>De knoppen van de radiator kunnen worden vergrendeld, zodat instellingen niet per ongeluk of door onbevoegde personen kunnen worden gewijzigd. Ga naar de modus vergrendelen/ontgrendelen, houd de "F"-knop ingedrukt.</p> 		<p>Als "LOC" op het display verschijnt:</p> <p>Houd de "F"-knop ingedrukt en druk op de "+"-knop om de knoppen te vergrendelen.</p>  <p>Activering wordt aangeduid door het relevante icoontje  dat op het display verschijnt</p> <p>Houd de "F"-knop ingedrukt en druk op de "-"-knop om de knoppen te ontgrendelen.</p> 
--	---	---

Als deze functie geactiveerd is en de stroomtoevoer hersteld wordt na een onderbreking van langer dan 30 minuten, wordt de modus hersteld die ten tijde van de onderbreking ingesteld was. Indien de bedrijfsmodus een van de drie programma P1 was, wordt in plaats daarvan het antivorst-programma geactiveerd, omdat u de tijd en dag moet instellen voordat u opnieuw een programma activeert.

7. Probleemoplossing

Probleem	Oplossing
De radiator wordt niet ingeschakeld.	Controleer of het apparaat op de netvoeding is aangesloten en of deze overeenkomt met de spanning op het typeplaatje van de radiator (bijv. 230 V AC, 50 Hz), en of de hoofdschakelaar aan de rechterkant ingeschakeld is (positie "I").
De radiator verwarmt niet.	Controleer of de bedrijfsmodus zoals gewenst is en, als u een vooraf ingesteld programma gebruikt, of voor de desbetreffende periode geen antivorst-modus is ingesteld. Indien de kamertemperatuur hoger is dan de ingestelde temperatuur, wordt de radiator niet ingeschakeld. Als u twijfelt, stelt u de comfort-modus en een gewenste temperatuur veel hoger in dan de kamertemperatuur. Zo kunt u controleren of de radiator correct functioneert.
De radiator blijft warm.	Controleer of de ingestelde temperatuur niet te hoog is en of er koude tocht langs de radiator komt. Tocht beïnvloedt de gemeten kamertemperatuur.
De radiator verwarmt niet voldoende.	Controleer of de ingestelde temperatuur niet te laag is, of de radiator alleen de ruimte verwarmt waarin hij geïnstalleerd is (houd deuren gesloten) en of de netvoeding correct is.
De radiator verwarmt in Eco-modus.	De radiator verwarmt tot de eco-temperatuur is bereikt of handhaaft deze temperatuur. Dit is niet ongewoon.
Het oppervlak van de radiator is erg warm.	Het is normaal dat het oppervlak warm is als de radiator aan staat. De maximumwaarden komen overeen met de grenswaarden die vastgelegd zijn in toepasselijke veiligheidsnormen. Indien de radiator altijd erg warm is, is hij niet groot genoeg voor de ruimte waarin hij gebruikt wordt, of is er sprake van tocht.

De temperatuur in de ruimte wijkt af van de temperatuur die is ingesteld.	Als u ten minste 4 uur gewacht heeft om de kamertemperatuur te laten stabiliseren, moet u wellicht eventuele verschillen tussen de door de radiator aangegeven temperatuur en de in de ruimte gemeten temperatuur compenseren. Zie hiervoor paragraaf 6.3, alinea "De kamertemperatuur corrigeren".
De radiator geeft een onaangename geur af.	Als de radiator nieuw is, kan het zijn dat u een onaangename geur ruikt als hij voor het eerst wordt gebruikt. Dit komt door residuen van het productieproces. Radiators die al gebruikt zijn, kunnen onaangename geuren afgeven als ze lange tijd niet zijn gebruikt en/of als ze gebruikt worden in verontreinigde ruimtes met een slechte luchtkwaliteit.
Het wifinetwerk dat door het product wordt gegenereerd, wordt niet gezien.	Ga met uw smartphone op een afstand van niet meer dan 3 m van het product staan. Het door het product gegenereerde wifinetwerk wordt in de wifi-instellingen van de smartphone weergegeven en niet in de app.
Er kan geen verbinding met het door het product gegenereerde wifinetwerk worden gemaakt om het configuratieproces van de app te starten.	Als u meer dan één product hebt, wordt geadviseerd om slechts één product tegelijkertijd aan te zetten en te configureren, zodat u niet in de war raakt door de verschillende wifinetwerken die worden aangemaakt. Zorg ervoor dat u het netwerkwachtwoord juist hebt ingevoerd Password123
Het mobiele apparaat maakt verbinding met het wifinetwerk dat door het product is gecreëerd, maar de app geeft een bericht aan dat er geen product is gevonden.	Loop niet weg bij het product tijdens het verbinden en zet elk ander wifinetwerk uit waar de smartphone automatisch verbinding mee kan maken (behalve het netwerk waar het product verbinding mee moet maken). Controleer op het display van het product dat de wifimodule actief is, door te controleren of het  icoontje brandt en knippert. Zo niet, volg dan de instructies om het product terug te brengen in de stand Access Point en probeer het opnieuw. Als de wifi van het product juist werkt, sluit dan de app, open deze opnieuw en voeg dan als eerste handeling het nieuwe product toe.
De app geeft geen enkel wifinetwerk aan waarmee het product kan worden verbonden.	Zorg ervoor dat het wifinetwerk waarmee u het product wilt verbinden ingeschakeld is en dat het signaal de ruimte bereikt waar het product wordt geïnstalleerd. Controleer de sterkte van het signaal in de ruimte waar het product wordt geïnstalleerd. Signalen die te zwak zijn of in sterkte variëren kunnen communicatieproblemen veroorzaken. In dat geval moet u het product naar een nieuwe locatie verplaatsen of het signaal van het wifinetwerk waarmee verbinding moet worden gemaakt, versterken.
Na het selecteren van het wifinetwerk waarmee het product verbinding moet maken, ontvangt u het bericht "Het product kan geen verbinding met het netwerk maken"	Controleer of u het juiste netwerkwachtwoord hebt ingevuld. Controleer of het wifinetwerk waarmee u het product wilt verbinden, een actieve internetverbinding heeft. Druk op de toets Retry totdat de procedure is gelukt. Als na meerdere pogingen de procedure nog niet is gelukt, moet het product teruggezet worden in de stand Access Point en schakel het 1 minuut lang uit. Herhaal dan de procedure vanaf het begin.

Als er een probleem met de wifimodule optreedt, geeft het product een foutcode aan waarmee u het probleem kunt oplossen:

Fout	Omschrijving	Oplossing probleem
E01	Het product kan geen verbinding met het wifinetwerk maken. Het ingevoerde wachtwoord voor het gewenste wifinetwerk (niet degene die door het product wordt aangemaakt) is onjuist of het netwerk is niet langer beschikbaar of zijn naam is gewijzigd.	Herhaal de aanmeldingsprocedure door verbinding te maken met het wifinetwerk dat door het product wordt gegenereerd en wacht tot de app opnieuw de netwerken weergeeft waarmee u verbinding kunt maken. Selecteer het gewenste netwerk en voer opnieuw het juiste wachtwoord in.
E02	Geen internetverbinding.	Herstel de internetverbinding.
E03	De Radialight-server kan niet bereikt worden.	<p>Wellicht wordt er onderhoud aan de server uitgevoerd. Dat duurt meestal niet langer dan een paar uur. Wacht en controleer of de fout niet meer wordt weergegeven en het wifi-icoontje niet meer knippert.</p> <p>Als het probleem blijft bestaan, verwijder dan de radiator uit de app, breng de wifi van het product terug in de stand Access Point en herhaal de gehele aanmeldingsprocedure alsof het product nieuw zou zijn.</p> <p>Als de fout wordt weergegeven na het succesvol afsluiten van de aanmelding, betekent dit dat het wifisignaal dat de radiator ontvangt, te zwak of te wisselend is en het niet mogelijk is om de verbinding te resetten. Verplaats in dit geval de radiator naar een andere positie of versterk het wifisignaal.</p>
E04	Registratie van het product op de Radialight-server is mislukt.	Het product wordt automatisch gereset naar de stand Access Point zodat de gehele aanmeldingsprocedure vanaf het begin kan worden herhaald.
E05	De verbinding van de wifimodule is verbroken.	Zet het product met de hoofdschakelaar 1 minuut lang uit en zet het dan weer aan.
E06	Fout wifimodule.	Als het probleem blijft aanhouden, zet het dan minimaal 1 uur lang uit om het tijdelijke interne geheugen te wissen en schakel het dan weer in.

8. Onderhoud

- Dit apparaat vereist geen specifiek onderhoud.
- Maak het apparaat, vooral het verwarmingspaneel, om de zes maanden met een droge doek schoon.
- Indien het apparaat gerepareerd dient te worden, moet u contact opnemen met een erkend technisch servicecentrum.
- Als de kabel vervangen dient te worden, moet een 2 x 1,00 mm²- of 3 x 1,00 mm²-kabel (type H05V2V2-F HAR) gebruikt worden, afhankelijk van de versie. Kabels met of zonder stekker mogen uitsluitend door gekwalificeerd personeel en niet door de eindgebruiker zelf worden vervangen om schade aan het apparaat en persoonlijk letsel te voorkomen.

9. Juridische mededeling



Milieu en recycling

Wij verzoeken u ons bij de bescherming van het milieu behulpzaam te zijn. Verwijder de verpakking daarom overeenkomstig de voor de afvalverwerking geldende nationale voorschriften.

Recycling van oude toestellen

Toestellen met dit kenmerk horen niet thuis in de vuilnisbak en moeten apart worden ingezameld en gerecycled volgens de ter plaatse geldende voorschriften en wetgeving.

NL - Informatie-eisen voor elektrische toestellen voor lokale ruimteverwarming

Typeaanduiding(en): KLIMA Wi-Fi					
Item	Symbol	Waarde	Eenheid	Item	Eenheid
Warmteafgifte				Type warmte-input, uitsluitend voor elektrische warmteopslagtoestellen (selecteer één)	
Nominale warmteafgifte	P_{nom}	(*) zie Tab. 1	kW	Handmatige sturing van de warmteopslag, met geïntegreerde thermostaat	neen
Minimale warmteafgifte (indicatief)	P_{min}	(*) zie Tab. 1	kW	Handmatige sturing van de warmteopslag, met kamer- en/of buitentemperatuurfeedback	neen
Maximale continue warmteafgifte	$P_{max,c}$	(*) zie Tab. 1	kW	Elektronische sturing van de warmteopslag, met kamer- en/of buitentemperatuurfeedback	neen
Aanvullend elektriciteitsverbruik				Door een ventilator bijgestane warmteafgifte	neen
Bij nominale warmteafgifte	e_{lmax}	0,000	kW	Type warmteafgifte/sturing kamertemperatuur (selecteer één)	
Bij minimale warmteafgifte	e_{lmin}	0,000	kW	Entrapswarmteafgifte, geen sturing van de kamertemperatuur	neen
In stand-bymodus	e_{lsb}	0,00049	kW	Twee of meer handmatig in te stellen trappen, geen sturing van de kamertemperatuur	neen
				Met mechanische sturing van de kamertemperatuur door thermostaat	neen
				Met elektronische sturing van de kamertemperatuur	neen
				Elektronische sturing van de kamertemperatuur plus dag-tijdschakelaar	neen
				Elektronische sturing van de kamertemperatuur plus week-tijdschakelaar	ja
				Andere sturingsopties (meerdere selecties mogelijk)	
				Sturing van de kamertemperatuur, met aanwezigheidsdetectie	ja
				Sturing van de kamertemperatuur, met openraamdetectie	ja
				Met de optie van afstandsbediening	neen
				Met adaptieve sturing van de start	neen
				Met beperking van de werkingstijd	neen
				Met black-bulbsensor	neen
Contactgegevens	Ermete Giudici S.p.A. - via L. da Vinci 27 - 20090 Segrate (MI) Italia				

Tabel 1		KLIMA 7 KLIMA 7 AS	KLIMA 10	KLIMA 15	KLIMA 20
Warmteafgifte					
Nominale warmteafgifte	P_{nom}	0,750	1,000	1,500	2,000
Minimale warmteafgifte (indicatief)	P_{min}	0,075	0,113	0,150	0,188
Maximale continue warmteafgifte	$P_{max,c}$	0,750	1,000	1,500	2,000

INSTRUKCJA OBSŁUGI GRZEJNIKA KLIMA

Przed uruchomieniem grzejnika należy dokładnie zapoznać się z poniższymi instrukcjami, aby uniknąć uszkodzeń i niebezpiecznych sytuacji. Jakiegokolwiek użycie grzejnika inne niż określone w niniejszej instrukcji obsługi może spowodować pożar, porażenie prądem elektrycznym lub obrażenia i utratę gwarancji.

Gwarancja nie obejmuje wad, pogorszenia, utraty, uszkodzenia lub szkody spowodowane przez lub w wyniku, nie odpowiedniego użycia lub nadużycia tego grzejnika. Prawa dyktowane przez prawo państwowe, nie są pomijane. Żaden z warunków niniejszej gwarancji nie wyłącza jakichkolwiek warunków bądź gwarancji przewidzianych przepisami prawa krajowego, które nie mogą zostać uchylone ani zmienione.

Przed rozpoczęciem użytkowania usunąć opakowanie i sprawdzić integralność produktu. W przypadku wad lub uszkodzeń, nie próbuj naprawiać go samodzielnie, lecz skontaktuj się z sprzedawcą.

Nie pozwalaj dzieciom bawić się opakowaniem i chroń środowisko poprzez utylizację opakowania zgodnie z krajowymi przepisami dotyczącymi przetwarzania odpadów.

1. Dla własnego bezpieczeństwa

- ❑ Ten grzejnik jest przeznaczony do użytku domowego i nie został przystosowany do użytku komercyjnego/przemysłowego, w samochodach, na statkach lub samolotach.
- ❑ Produkt może być stosowany przez dzieci od 8 roku życia oraz osoby o ograniczonych zdolnościach fizycznych, czuciowych lub umysłowych, lub z niedostatecznym doświadczeniem i wiedzą, pod warunkiem że są one pod nadzorem osoby odpowiedzialnej za ich bezpieczeństwo lub zostały odpowiednio poinstruowane. Dzieci nie powinny bawić się produktem. Czyszczeniem i przeglądami użytkownika nie powinny się zajmować dzieci bez nadzoru.
- ❑ Dzieci poniżej 3 roku życia powinny być trzymane z dala od urządzenia chyba że są pod stałą opieką
- ❑ Dzieci pomiędzy 3 a 8 rokiem życia powinny tylko włączać i wyłączać urządzenie, oczywiście tylko wtedy, gdy umiejscowienie grzejnika na to pozwala, nie zapominając o ciągłym nadzorze i wytłumaczeniu jak korzystać z urządzenia w bezpieczny sposób. Dzieci pomiędzy 3 a 8 rokiem życia nie powinny wyciągać wtyczki z gniazda, operować termostatem, czyścić grzejnik lub wykonywać kontrole użytkowe urządzenia
- ❑ **UWAGA – Niektóre elementy tego produktu mogą być bardzo gorące i mogą spowodować oparzenia. Szczególną uwagę trzeba poświęcić gdy w pobliżu znajdują się dzieci i osoby starsze.**
- ❑ Upewnij się, że zasilanie sieciowe odpowiada nominalnej mocy: 230V AC, 50Hz.
- ❑ Nie wolno dopuścić, aby zwierzęta lub dzieci bawiły się lub dotykały urządzenie. Uwaga! Panel może być bardzo gorący podczas jego pracy (około 80°C/176°F);

- ❑ **OSTRZEŻENIE: W celu uniknięcia przegrzania, nie należy przykrywać grzejnika.** Nie kładź niczego na grzejniku i nie zastawiaj go podczas jego pracy. Jest to wyraźnie napisane na produkcie lub wskazuje na to symbol:



- ❑ Nie należy korzystać z produktu w pomieszczeniach nasyconych gazem wybuchowym, opary generowane przez rozpuszczalniki, farby lub łatwopalne opary / gaz.
- ❑ Jeśli kabel i / lub wtyczka są uszkodzone, nie należy ich naprawiać samemu, ale zwrócić produkt do serwisu technicznego lub autoryzowanego centrum naprawy aby naprawił go wyspecjalizowany pracownik w celu uniknięcia ryzyka uszkodzenia.
- ❑ Zawsze umieścić produkt tak, aby wtyczka była zawsze dostępna
- ❑ Nigdy nie umieszczać tego urządzenia bezpośrednio pod gniazdem zasilania.
- ❑ Nie umieszczaj żadnych rzeczy lub papieru wewnątrz grzejnika.

2. Twój produkt

- ❑ Po za grzejnikiem w pudełku znajduje się (rysunek 1):
 - 1 metalowy wspornik do montażu na ścianie (przymocowany do grzejnika);
 - 4 kołki rozporowe 8x50mm;
 - 4 wkręty metalowe 5x60mm;
- ❑ Skontaktuj się z sprzedawcą jeśli coś jest uszkodzone lub czegoś brakuje.

3. Bezpieczne pozycjonowanie grzejnika

- ❑ Produkt używać wyłącznie w pozycji poziomej;
- ❑ Produkt ten jest wyposażony w podwójny układ izolacji elektrycznej (klasa II) i w związku z tym nie wymaga uziemienia;
- ❑ Zawsze należy przestrzegać minimalnych odległości od ścian, mebli i / lub obiektów, jak pokazano na rysunku 2.
- ❑ Nie wolno instalować urządzenia na powierzchni wykonanej z **drewna lub tworzywa sztucznego**.
- ❑ Produkt ten jest odporny na zachłapania IP24. Dlatego może być stosowany w łazienkach lub innych obszarach w których występuje wilgoć pod warunkiem, że nie jest zainstalowany w strefie wanny lub prysznicza (Volume 1 rysunek 2).
- ❑ Nie można dopuścić do tego by ludzie w wannie lub pod prysznicem, mogli dosięgnąć do pokrętła regulacyjnego.

4. Montaż

- ❑ Zdejmij metalowy wspornik, który jest umieszczony z tyłu grzejnika, poprzez zwolnienie górnych zatrzasków a później dwóch dolnych zatrzasków jak to jest pokazane na rysunku 4.
- ❑ Postaw metalowy wspornik na ziemi i użyj go jako szablon do odmierzenia dwóch dolnych dziur montażowych. (rysunek 5A)
- ❑ Unieś metalowy wspornik do góry tak aby dolne otwory zgadzały się z tymi odmierzonymi na ścianie i odmierz dwie górne dziury montażowe. (rysunek 5B)
- ❑ Wywierć wcześniej oznaczone cztery dziury i umieść w nich kołki rozporowe. (rysunek 6)
- ❑ Zawieś metalowy wspornik za pomocą czterech załączonych śrub. (rysunek 7)
- ❑ Umieść grzejnik zaczynając od dwóch dolnych zatrzasków, i później zatrzasknij dwa górne na ich pozycje (rysunek 8)
- ❑ Jeżeli będzie potrzeba zdjęcia grzejnik z metalowego wspornika, rekomendujemy zdjęcie dolnych zatrzasków najpierw a później górnych.

5. Połączenia elektryczne

- ❑ Produkt musi być zasilany napięciem 230V AC 50Hz.
- ❑ Produkt musi być dostarczony z kablem i wtyczką lub kablem do instalacji. Jeśli produkt jest wyposażony w wtyczkę a jest montowany w Francji, podłącz go do sieci elektrycznej poprzez odcięcie wtyczki i połączenie go za pomocą kostki elektrycznej.
- ❑ Jeżeli produkt jest wyposażony w kabel do instalacji, należy go podłączyć do zasilania sieciowego za pomocą kabla 3-żyłowego (Brązowy = zasilanie, Niebieski = Neutralny, Czarny = przewód pilota) i skrzynki przyłączeniowej. **Jeśli nie korzystasz z funkcji pilota przewodowego, podłącz tylko fazę i neutralny: Produkt będzie działał poprawnie nawet bez programatora zewnętrznego.**
- ❑ W łazienkach, kuchniach i innych pomieszczeniach wilgotnych, zainstalować styki co najmniej 25 cm od podłogi.
- ❑ Podłączenie elektryczne do zasilania sieciowego musi również zawierać przełącznik 2-biegunowy z minimalnej przysięszonej styków 3mm. Jako priorytet, zawsze przestrzegać przepisów krajowych przy podłączaniu urządzenia.
- ❑ Zabronione jest podłączenie urządzenia do uziemienia. **NIE PODŁĄCZAĆ PRZEWODU PILOTA (CZARNY) DO UZIEMIENIA.**
- ❑ Jeżeli produkt jest zasilany przez wyłącznik różnicowy 30mA, upewnij się, że przewód sterujący jest również kontrolowany przez przełącznik różnicowy.

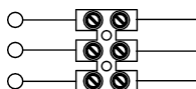

L Faza (brązowy)
Pilot (czarny) – **NIE PODŁĄCZAĆ DO UZIEMIENIA**
N Neutralny (niebieski)



6. Korzystanie z produktu

6.1 Panel termostatu

- A – Włącznik / Wyłącznik
- B – Zmiana funkcji
- C – Specjalne funkcje
- D – Zwiększenie / Aktywacja
- E – Zmniejszenie / Dezaktywacja
- F – Wyświetlacz
- G – Główny przełącznik

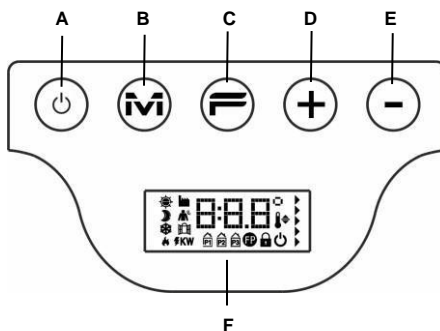





6.2 Obsługa

6.2.1 Uruchamianie ekranu

<p>Jeżeli ekran nie jest włączony naciśnij dowolny przycisk aby go podświetlić. Ekran podświetla się i pozostaje podświetlony przez 30 sekund po ostatnim naciśnięciu przycisku.</p>		<p>Jeżeli ekran jest wyłączony pierwsze naciśnięcie przycisku powoduje tylko podświetlenie ekranu bez aktywowania funkcji przypisanej do przycisku.</p>
--	---	---

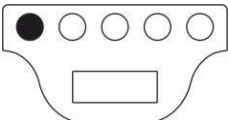

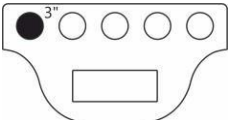

6.2.2 Włączanie/Wyłączenie grzejnika

Zasilanie grzejnika sterowane jest przez wyłącznik główny (G) znajdujący się po prawej stronie grzejnika. Po wyłączeniu tego przełącznika następuje wyłączenie zasilania termostatu, co spowoduje utratę wszystkich zapisanych parametrów po około 30 minutach i przywrócenie ustawień domyślnych. Zalecamy używanie tego przełącznika tylko wtedy, gdy grzejnik nie będzie używany przez dłuższy czas. Zamiast tego możemy używać przycisku włączania / wyłączenia (A) aby uniknąć utraty zapisanych ustawień.







<p>Kiedy grzejnik jest włączony za pomocą głównego przełącznika na boku urządzenia, ekran podświetli się i ikonka gotowości zaświeci się.</p>		
<p>Aby włączyć grzejnik naciśnij przycisk włącz/wyłącz</p> 		<p>Grzejnik zawsze włącza się na temperaturze komfortowej. Jeżeli grzejnik jest nowy bądź nie miał zasilania przez więcej niż 30 minut, temperatura komfortowa jest w standardzie ustawiona na 19°C.</p>
<p>Aby wyłączyć grzejnik przytrzymaj przycisk włącz/wyłącz przez co najmniej 3 sekundy.</p> 		<p>Wyłączając grzejnik za pomocą głównego wyłącznika na boku urządzenia na dłużej niż 30 minut spowoduje utratę wszystkich zapisanych danych (data, godzina, ustawione temperatury itp.)</p>

6.2.3 Wybieranie odpowiedniej funkcji

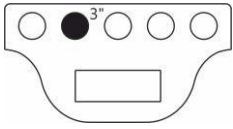
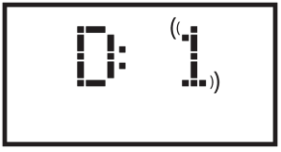
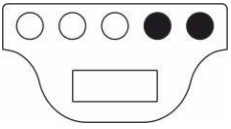
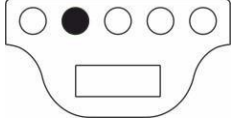
<p>Przycisk „M” pozwala na zmianę obecnej funkcji i wybranie pożądanej</p> 		<p>Funkcje aktywowane są w kolejności:</p>  <p>Gdy minie 30 sekund od ostatniego wciśnięcia przycisku „M” aktywacja funkcji zacznie się od początku, dla ułatwienia rozpoczyna się od ustawienia funkcji komfort.</p>
---	--	---

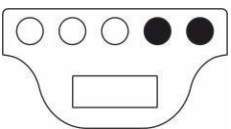
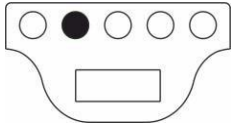
Ikona	Opis	Kiedy używać
	Komfort	Grzejnik pracuje by utrzymać ustaloną temperaturę komfortową.
	Eco	Gdy jesteś po za domem przez krótki okres czasu (od 2 do 48 godzin) lub gdy śpisz. Grzejnik pracuje z ustaloną temperaturą Eco w celu oszczędzania energii.
	Anti-freeze	Gdy jesteś po za domem przez długi czas (więcej niż 48 godzin). Temperatura jest automatycznie ustawiona na $7 \pm 3^{\circ}\text{C}$ i nie może zostać zmieniona.
	Program P1	Gdy chcesz korzystać z programu dostosowanego specjalnie dla tych co nie przebywają w domu. TEN PROGRAM MOŻNA RÓWNIEŻ MODYFIKOWAĆ WEDŁUG INSTRUKCJI ZAMIESZCZONEJ W PUNKCIE 6.2.6.
	Pilot wire	Gdy chcesz sterować grzejnikiem za pomocą zewnętrznego pilota.

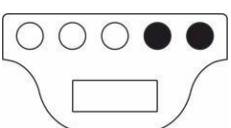
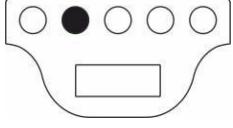
6.2.5 Ustawianie dnia i godziny

<p>Ustaw datę i godzinę aby korzystać z zapamiętanych programów, można tego dokonać poprzez przytrzymanie przez 3 sekundy przycisku „M”.</p> 		<p>Dzień zacznie migać, dzień tygodnia można teraz ustawić. (1- poniedziałek, 2- wtorek .. 7-niedziela), poprzez wciśnięcie przycisków „+” lub „-”</p> 
<p>Naciśnij przycisk „M” aby potwierdzić dzień i przejść do ustawiania godziny.</p> 		<p>Godzina zacznie migać, godzinę można teraz ustawić poprzez wciśnięcie przycisków „+” lub „-”</p> 
<p>Naciśnij przycisk „M” aby potwierdzić godzinę i przejść do ustawiania minut.</p> 		<p>Minuty zaczną migać, minuty można teraz ustawić poprzez wciśnięcie przycisków „+” lub „-”</p> 
<p>Naciśnij przycisk „M” aby potwierdzić minuty i zapisać ustawienia do pamięci.</p> 		<p>Termostat wróci do poprzedniego trybu który był uruchomiony przed ustawianiem daty i godziny.</p> <p>Gdy próbowałeś włączyć zapisany program bez ustawienia dnia i godziny, termostat przejdzie automatycznie w tryb ustawiania daty i godziny.</p>

6.2.6 Modyfikowanie programu P1







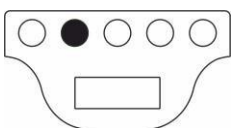

Program P1 może być zmieniany według uznania i potrzeb użytkownika. Modyfikacja P1 daje użytkownikowi możliwość na ustawienie pożądanej temperatury otoczenia, wybierając pomiędzy temperaturami Komfort, Eco i Anti-freeze na każdą godzinę w każdym dniu tygodnia

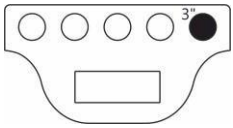
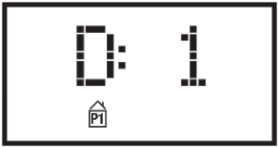
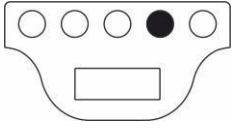

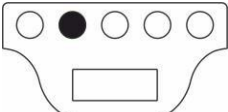
Aby ustawić temperaturę dla każdego trybu zwróć do rozdziału 6.2.4.

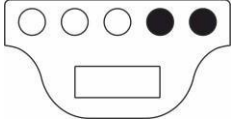
Każda godzina dnia pokazuje jaki jest ustawiony aktualny poziom temperatury dla programu P1. W przypadku, gdy grzejnik jest uruchomiony po raz pierwszy użyty jest profil pokazany w rozdziale 6.2.3.1.

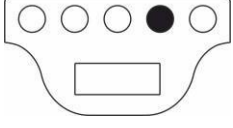
W celu wyświetlenia lub zmiany programu P1 postępuj zgodnie z poniższą instrukcją:

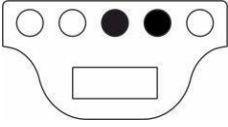

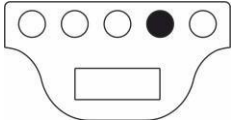

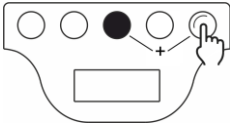



<p>Naciśnij „M” aby wybrać program P1</p> 		<p>W przypadku, gdy godzina nie została ustawiona (nowy produkt lub brak zasilania przez ponad 30 minut) uruchomiona zostanie procedura ustawiania godziny i daty (więcej informacji w rozdziale 6.2.5).</p>
---	---	--

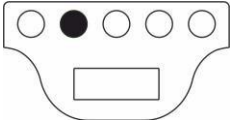

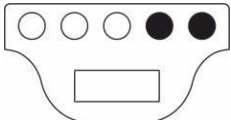

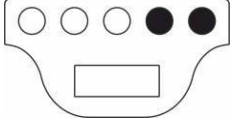

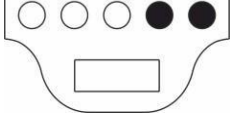



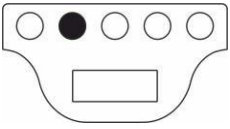

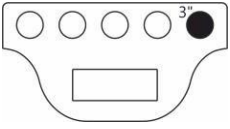

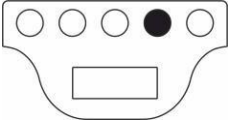

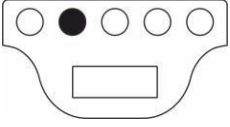

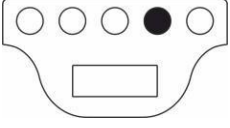
<p>Aby wyświetlić program P1 przytrzymaj przycisk „-” przez 3 sekundy</p> 		<p>Pierwszy dzień jest do wglądu/modyfikacji jest teraz wyświetlany (1=poniedziałek).</p>
<p>Naciśnij przycisk „+” aby zobaczyć/modyfikować pierwszą godzinę</p> 		<p>Przyciśnij przycisk „M” aby wybrać pożądaną temperaturę pomiędzy Komfortową, Eco oraz Anti-freeze:</p>   <p>Wyświetlana temperatura po wybraniu odpowiedniej godziny w danym dniu jest to obecnie zapamiętana w programie P1.</p>
<p>Użyj „+” i „-” aby wybrać daną godzinę z dnia 1 i zobaczyć/zmodyfikować zapisany poziom temperatury dla każdej z nich.</p> 		<p>Godzina, która jest wyświetlana jest to godzina rozpoczęcia. Dla przykładu: H:23 jest wyświetlone, oznacza to że zmiana obejmuje przedział czasowy pomiędzy 23:00 a 00:00.</p>
<p>Po ustawieniu temperatur dla wszystkich godzin w ciągu dnia 1, naciśnij przycisk „+” aby przejść do dnia 2</p> 		<p>Naciśnij przycisk „+” aby zobaczyć/zmodyfikować temperatury dla każdej godziny w dniu 2, jak opisano powyżej dla dnia 1. Możesz ustawić automatycznie ten sam program dnia 1 dla dnia 2 przez przytrzymanie przycisku „F” i naciśnięcie przycisku „+”</p>  <p>Uwaga: masz możliwość kopiowania i wklejania tego samego programu dniowego TYLKO WTEDY gdy wyświetlany jest dzień tygodnia który chcesz zmodyfikować (jak pokazano na obrazku), ALE NIE jak wyświetlana jest godzina.</p>

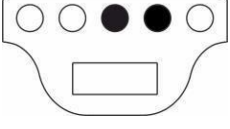
<p>Gdy ostatni dzień (dzień 7) zostanie ustawiony naciśnij przycisk „+” aby zakończyć programowanie.</p> 		<p>Napis END pojawi się na wyświetlaczu. Następne naciśnięcie przycisku „+” umożliwi ci zapisanie programu.</p>
<p>Napis OK wyświetli się na ekranie przez 5 sekund, potwierdzając że program został zapamiętany. System jest teraz przygotowany do pracy zgodnie z ustawionymi temperaturami według programu P1</p>		<p>Uwaga: Jest możliwe wyjście z programowania bez konieczności wyświetlania wszystkich godzin aż do dnia 7. Wystarczy tylko przytrzymać przycisk „F” i wcisnąć przycisk „-”</p> 
<p>Ponadto:</p> <ul style="list-style-type: none"> - Możesz przerwać wyświetlanie/zmianę w każdym momencie usuwając wszelkie zmiany które nie zostały zapisane, poprzez naciśnięcie przycisku „Włącz/Wyłącz”. - Przywrócenie ustawień domyślnych skasuje cały program P1 poprzednio stworzony (zajrzyj do rozdziału 6.3) - Jeżeli nie zostanie wciśnięty żaden przycisk przez 90 sekund podczas programowania, wszelkie zmiany zostaną cofnięte i ustawienia fabryczne zostaną załadowane. <p>Podczas programowania, elementy grzewcze zostaną automatycznie wyłączone i grzejnik nie będzie ogrzewał.</p>		

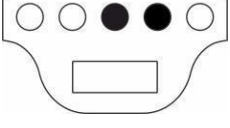

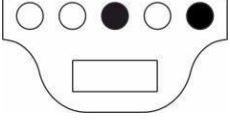

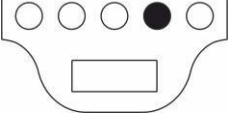





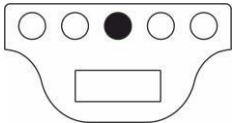

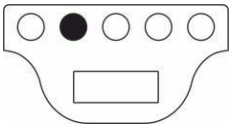
PRZYKŁAD: JAK ZAPROGRAMOWAĆ WŁASNY PROGRAM

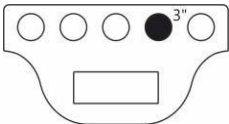

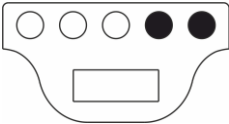

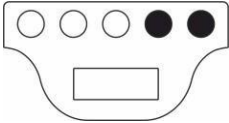

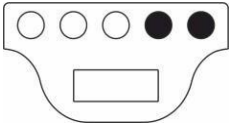
Zobaczmy jak zaprogramować nowy grzejnik i zmienić temperaturę ECO na KOMFORT jedną godzinę wcześniej (06:00 rano jest to ustawienie fabryczne) dla każdego dnia od Poniedziałku do Piątku.

<p>Naciśnij „M” aby wybrać Program P1</p>		
<p>Ustaw aktualny dzień tygodnia (pierwsze użycie grzejnika) używając przycisków „+” lub „-”</p>		
<p>Naciśnij „M” i ustaw aktualną godzinę (pierwsze użycie grzejnika) używając przycisków „+” lub „-”</p>		
<p>Naciśnij „M” i ustaw minuty (pierwsze użycie grzejnika) używając przycisków „+” lub „-”</p>		

<p>Naciśnij „M” aby zakończyć ustawianie czasu. System automatycznie przejdzie do programu P1.</p>		
<p>Przytrzymaj „-” przez 3 sekundy, aby wyświetlić / zmodyfikować dnia 1.</p>		
<p>Naciskaj „+” aż zobaczysz H:05 na wyświetlaczu (to jest godzina którą chcemy zmienić z ECO na KOMFORT).</p>		
<p>Naciśnij „M” dwa razy aby zmienić temperaturę z ECO na KOMFORT.</p>		
<p>Naciskaj „+” aż zobaczysz D:2 na wyświetlaczu (wtorek).</p>		
<p>Aby skopiować i wkleić ten sam program dnia 1 do dnia 2, przytrzymaj „F” i naciśnij „+”. System automatycznie skopiuje dane i przejdzie do dnia 3 (środa).</p>		
<p>Powtarzaj czynność opisaną powyżej aż zobaczysz D:6 na wyświetlaczu.</p>		
<p>Ponieważ nie chcemy zmieniać dnia 6 i 7, możemy wyjść z programowania poprzez przytrzymanie przycisku „F” i naciśnięcie „-”. Na wyświetlaczu pojawi się napis „END”.</p>		
<p>Naciśnij „+” aby potwierdzić zmiany. Na wyświetlaczu przez 5 sekund będzie migać napis „OK”</p>		

6.3 Funkcje specjalne

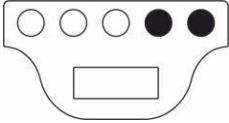

<p>Kilkukrotne wciśnięcie przycisku „F” umożliwia zmianę różnych funkcji specjalnych dostępnych w kolejności</p> 		<p>Aby opuścić menu funkcji specjalnych po prostu poczekaj 12 sekund lub wciśnij przycisk „M” aby wrócić do podstawowego menu.</p> 
<p>Przywracanie ustawień fabrycznych</p> <p>Uwaga: Przywrócenie ustawień fabrycznych NIE spowoduje usunięcia zapisanych ustawień połączenia Wi-Fi.</p>		<p>Aby przywrócić ustawienia grzejnika do ustawień fabrycznych przytrzymaj przez co najmniej 3 sekundy przycisk „+”</p> 
<p>Wi-Fi</p> <p>Dzięki tej funkcji można podłączyć grzejnik do sieci Wi-Fi z dostępem do Internetu i sterować nim za pośrednictwem aplikacji.</p> <p>Więcej informacji znajduje się w pkt 6.3.3.</p>		<p>Aktywację (ON) lub dezaktywację (OFF) tej funkcji uzyskuje się naciskając odpowiednio „+” lub „-”.</p>  <p>Aktywacja jest sygnalizowana pojawieniem się odpowiedniej ikony na wyświetlaczu</p> 
<p>Czujnik obecności (opcjonalnie)</p> <p>Funkcja ta umożliwia sterowanie grzejnikiem za pomocą wbudowanego czujnik ruchu, który wykrywa czy ktoś się znajduje w jego zasięgu i automatycznie reguluje poziom temperatury w celu zoptymalizowania komfortu i oszczędności energii.</p> <p>Więcej szczegółów w rozdziale 6.3.1.</p>		<p>Włączeniu bądź wyłączenie możliwe jest za pomocą przycisków „+” oraz „-”.</p>  <p>Włączenie jest sygnalizowane odpowiednią ikonką na ekranie (ON – dla włączonego, OFF – dla wyłączonego).</p> 
<p>Czujnik otwartego okna</p> <p>Funkcja ta umożliwia wykrycie otwarcia okna i automatycznie włącza funkcję Anti-freeze. Więcej szczegółów w rozdziale 6.3.2</p>		<p>Włączeniu bądź wyłączenie możliwe jest za pomocą przycisków „+” oraz „-”.</p>  <p>Włączenie jest sygnalizowane odpowiednią ikonką na ekranie (ON – dla włączonego, OFF – dla wyłączonego)</p> 

<p>Dzienne zużycie</p> <p>Funkcja ta umożliwia sprawdzenie ile energii zużył grzejnik w przeciągu 24 godzin.</p>		<p>Jeżeli wskaźnik zużycia miga oznacza to że zebrane dane są z okresu krótszego niż 24 godziny.</p> <p>Uwaga: Wyświetlane jest tylko przybliżone zużycie, które może być inne niż wskazywane przez specjalne mierniki odpowiednie do tego celu.</p>
<p>Tygodniowe zużycie</p> <p>Funkcja ta umożliwia sprawdzenie ile energii zużył grzejnik w przeciągu 7 dni.</p>		<p>Jeżeli wskaźnik zużycia miga oznacza to że zebrane dane są z okresu krótszego niż 7 dni.</p> <p>Uwaga: Wyświetlane jest tylko przybliżone zużycie, które może być inne niż wskazywane przez specjalne mierniki odpowiednie do tego celu.</p>
<p>Wyświetla temperaturę otoczenia</p>		<p>Wyświetlana jest temperatura otoczenia zmierzona przez urządzenie.</p>
<p>Korekta temperatury otoczenia</p> <p>Funkcja ta umożliwia edycję temperatury otoczenia mierzonej przez grzejnik w celu zarządzania mocą grzewczą. Jeżeli jest potrzeba korekcy w celu zniwelowania błędów odczytu z względu na bliskość źródła ciepła bądź z względu na prąd zimnego powietrza.</p>		<p>Wyświetlana jest migająca wartość korekcy która ma być wprowadzona. Aby edytować naciśnij przycisk „+” lub „-”.</p>  <p>Jeżeli dla przykładu temperatura otoczenia według grzejnika to 19,2°C a temperatura otoczenia zmierzona to 19,5°C popraw ją o +0,3°C.</p> <p> Zawsze odczekaj co najmniej 4 godziny, aż temperatura się wyrówna, przed jakąkolwiek zmianą.</p>

6.3.1 Czujnik obecności (opcjonalnie)

Funkcja ta pozwala grzejnikowi wykrycie czy w zasięgu znajdują się ludzie czy nie, i automatycznie regulować poziomem temperatury, w celu uzyskania optymalnego komfortu i oszczędności energii.

Dzięki tej funkcji, która może zostać włączona tylko w trybie komfortowym, grzejnik cały czas monitoruje pomieszczenie i jeżeli nie zostanie wykryty żaden ruch, zmniejszona temperatura komfortowa zgodnie z poniższą tabelką:

Czas nieobecności	Zmniejszenie temperatury komfortowej	Symbole wyświetlane na ekranie termostatu
60 minut	1,0°C	Symbole czujnika obecności i tryb komfortowego migają razem  (())
90 minut	2,0°C	
120 minut	3,5°C	
38 godzin	Anti-freeze 7±3°C	

Obniżenie temperatury odnosi się do temperatury komfortowej. Jeżeli grzejnik jest w trybie Eco lub Anti-freeze żadna zmiana w temperaturze która ma być utrzymana w pomieszczeniu nie zostanie zauważona.

Jeżeli ktoś zostanie wykryty w pomieszczeniu przez 10 kolejnych minut, temperatura automatycznie powróci do temperatury komfortowej bez żadnych obniżen. To samo się stanie gdy, podczas temperatury zadanej która została zmniejszona z uwagi na nie obecność ludzi w pomieszczeniu, naciśniemy przycisk „M”.

UWAGA:

Poprawne działanie tej funkcji może zależeć od pozycji w której zamontowany jest grzejnik w pomieszczeniu. Aby wybrać odpowiednie miejsce montażu pamiętaj że czujnik ruchu wykrywa w strefie w kształcie X i żaden obiekt nie może stać na jego drodze. Wykrywanie obecności jest bardziej efektywne, gdy osoby przechodzą przed grzejnikiem niż jak idą w jego stronę.

6.3.2 Czujnik otwartego okna

Funkcja ta umożliwi wykrycie otwartego okna i automatyczne przejście grzejnika w tryb Anti-freeze.

Jeżeli zostanie wykryty nagły spadek temperatury podczas normalnej pracy zostanie uruchomiony tryb Anti-freeze w celu zmniejszenia strat energii. Na wyświetlaczu symbole okna oraz anti-freeze migają razem, podczas gdy symbol trybu pracy ustawiony przez użytkownika jest cały czas włączony

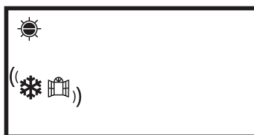

Przełączenie w tryb normalnej pracy nie następuje automatycznie, lecz musi być uruchomiony przez naciśnięcie przycisku „M”.





UWAGA:

Poprawne działanie tej funkcji może zależeć od pozycji grzejnika w pomieszczeniu, obecność prądów powietrznych, temperatury zewnętrznej i jak długo okno pozostaje otwarte.

6.3.3 Korzystanie z aplikacji

Dzięki tej funkcji można podłączyć grzejnik do sieci Wi-Fi z dostępem do Internetu i sterować nim za pomocą dedykowanej aplikacji Radialight®.

Aby podłączyć produkt do sieci Wi-Fi, możesz postępować zgodnie z instrukcjami podanymi bezpośrednio w aplikacji lub zapoznać się ze szczegółowym przewodnikiem ilustrującym procedurę krok po kroku. Wybierz przewodnik dla swojego systemu operacyjnego:

	android	Apple iOS
POBIERZ APLIKACJĘ	 www.radialight.com/app-android	 www.radialight.com/app-ios
OTWÓRZ SKRÓCONY PRZEWODNIK	 www.radialight.com/android-start-guide	 www.radialight.com/ios-start-guide

Po zakończeniu połączenia w aplikacji wyświetlana jest następująca strona główna:



Lista produktów: umożliwia przeglądanie listy wszystkich zarejestrowanych produktów i dodawanie nowych. Aktualnie aktywny tryb pracy, nazwa strefy produktu i wskaźnik ogrzewania są wyświetlane dla każdego produktu. Dalsze opcje pozwalają zmienić przynależną strefę, nazwę produktu i wyłączyć produkt. Przeciągając ikonę produktu z prawej do lewej, znajdziesz przycisk, który pozwala go usunąć z listy produktów.

Aktywny tryb pracy: ikona reprezentuje aktywny tryb pracy przy użyciu tego samego symbolu na wyświetlaczu produktu. Jeśli tryb zaprogramowany jest aktywny, symbol zegara jest otoczony ikoną zaplanowanego trybu pracy. Nazwa aktywnego programu jest również pokazana po prawej stronie tego symbolu.

Zużycie energii z ostatnich 7 dni: Wyświetlane jest zużycie energii z ostatnich 7 dni, a trend zużycia jest przedstawiany graficznie dla każdego dnia. Naciśnięcie wykresu powoduje przejście do sekcji zużycia energii.

Nazwa strefy: wskazuje nazwę przypisaną do strefy i można ją dostosować zgodnie z poniższymi instrukcjami.

Zarządzanie strefami: umożliwia przeglądanie listy zdefiniowanych stref oraz usuwanie lub tworzenie nowych. Dla każdej strefy wskazana jest nazwa i aktywny tryb, zmiana trybu pracy jest automatyczna dla wszystkich produktów w danej strefie.

Programowanie tygodniowe: naciśnięcie tej ikony powoduje przejście do sekcji programowania tygodniowego. W tej sekcji można zmodyfikować domyślny program predefiniowany lub utworzyć nowy. Każdy program może mieć własną nazwą i kolor, aby ułatwić jego identyfikację.

Anulowanie programu można wykonać, przeciągając ikonę programu z prawej strony na lewą.

Zużycie energii: naciskając tę ikonę, można uzyskać dostęp do sekcji analizy użytkownika i przeglądać dane o zużyciu energii dobowej, tygodniowo lub miesięcznie - podzielone według obszaru lub zgrupowane.

Wybór trybu pracy: pozwala wybrać tryb pracy, wybierając pomiędzy trybem Komfort, Eko, Przeciwzamrożeniowy, Program tygodniowy, Pilot wire i Stand-by. W razie potrzeby można ustawić czas dla zmiany trybu: pod koniec ustawionego czasu tryb aktywny powróci do poprzednio ustawionego trybu pracy.

Nazwa produktu: Nazwa produktu jest wyświetlana na środku wyświetlacza. Jeśli strefa zawiera kilka produktów, odpowiednie informacje (nazwa i temperatura pokojowa) są wyświetlane w kolejności.

Temperatura pokojowa: wyświetlana jest temperatura zmierzona przez czujnik produktu.

Ustawienia: w tej sekcji można:

- Zobaczyć samouczek wyjaśniający, jak działa aplikacja;
- Aktywować kontrolę kosztów, umożliwiając również dodanie do kWh wartości ekonomicznej poprzez określenie jednostkowego kosztu energii;
- Zarządzać powiadomieniami użytkownika, jeśli czujnik otwartego okna jest włączony i uruchomił się;
- Zarządzać powiadomieniami użytkownika, jeśli jeden lub więcej produktów jest w trybie Stand-by, a strefa, do której należą, jest ustawiona na inny tryb;
- Zarządzać powiadomieniem użytkownika, jeśli ustawiony próg zużycia lub wydatku zostanie przekroczony;
- Zmień hasło do konta;
- Zmiana zgody na otrzymywanie aktualizacji i promocji.

Naciskając środek strefy, możesz uzyskać dostęp do widoku szczegółowych ustawień strefy:

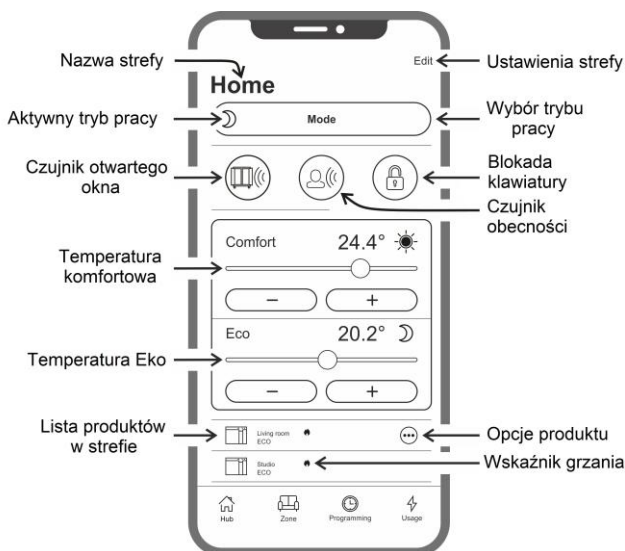

Czujnik otwartego okna: umożliwia włączenie lub wyłączenie wykrycia otwarcia okna (patrz punkt 6.3.2).

Czujnik obecności: umożliwia włączenie lub wyłączenie funkcji automatycznej redukcji temperatury (względem temperatury Komfort), jeśli w pomieszczeniu nikt nie przebywa przez określony czas (patrz punkt 6.3.1).

Blokada klawiatury: pozwala zablokować klawisze regulacji na produkcie, zapobiegając przypadkowym lub nieautoryzowanym zmianom (patrz punkt 6.4).

Lista produktów w strefie: wszystkie produkty należące do wybranej strefy są wymienione na dole ekranu. Każdy z nich pokazuje swoją nazwę, aktywny tryb pracy i status ogrzewania.

Wskaźnik grzania: ikona świeci się, gdy temperatura w pomieszczeniu jest niższa niż pożądana, a produkt działa w celu ogrzania pomieszczenia.

Opcje produktu: pozwala zmienić strefę przynależności, nazwę produktu lub go wyłączyć.

Ustawienia strefy: pozwala zmienić nazwę strefy i obraz tła.

Niespójności

Jeśli strefa zawiera 2 lub więcej produktów, a jeden lub więcej z nich ma inne ustawienie niż ustawiony dla strefy, występuje niespójność. Sytuacja ta, zwykle spowodowana ręczną modyfikacją parametru produktu, może odnosić się do trybu pracy, stanu czujników lub wartości temperatur Komfort i Eko.

Jeśli ten warunek wystąpi, aplikacja podświetli niespójny parametr strefy, wyświetlając specjalny symbol, jak pokazano na rysunku po prawej stronie. Ten sam symbol pojawia się w lewym górnym rogu ikony produktu pokazanej na liście w dolnej części ekranu. W ten sposób użytkownik jest informowany o produkcie, który powoduje, że ma jedno lub więcej ustawień, które nie są zgodne z ustawieniami zdefiniowanymi dla strefy.

Naciskając symbol niespójności, można zresetować wszystkie produkty z parametrami wcześniej wybranymi dla strefy.

Jeśli zmiana ustawień jednego lub więcej produktów była zamierzona, można zignorować wyświetlane symbole. Jeśli jednak korzystanie ze zróżnicowanych ustawień jest powtarzalne, zaleca się przypisanie produktów do różnych stref, aby móc nimi zarządzać bez ciągłego wyświetlania symboli niespójności.

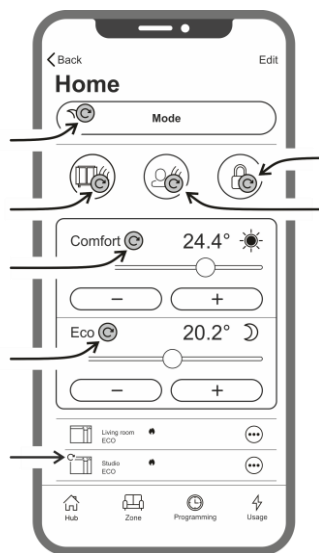

Dobrze wiedzieć, że:

Zarządzanie czasem

Bieżące ustawienie godziny i dnia tygodnia jest przekazywane do grzejnika w momencie jego pierwszej rejestracji. Jednocześnie przechowywana jest strefa czasowa obszaru, w którym produkt jest zainstalowany. Zarządzanie czasem letnim nie jest automatyczne, ale po zmianie czasu wystarczy wysłać dowolne polecenie do strefy, aby upewnić się, że produkty należące do strefy zostały zresetowane z poprawnym czasem.

Brak energii

Jeśli zasilanie zostanie odłączone na dłużej niż 30 minut, grzejnik traci wiele ustawień wewnętrznych. Po przywróceniu zasilania urządzenie automatycznie ponownie łączy się z siecią Wi-Fi i ustawia tryb Stand-by. Dlatego zaleca się sprawdzenie szczegółów obszaru, aby sprawdzić, czy tryb ustawiony w aplikacji i tryb aktywny w produkcji są takie same. W sekcji ustawień można aktywować powiadomienie użytkownika, jeśli produkt przejdzie w tryb Stand-by, a strefa, do której należy, jest ustawiona na inny tryb.

Powiadomienia









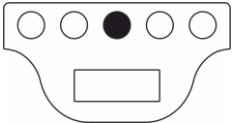

W sekcji ustawień możesz określić, czy chcesz otrzymywać powiadomienia, gdy wystąpią określone zdarzenia. Powiadomienia są wyświetlane, gdy aplikacja jest otwarta lub zamknięta, jeśli zostały autoryzowane podczas instalacji aplikacji. Aby sprawdzić stan aktywacji powiadomień, zapoznaj się z instrukcjami systemu operacyjnego smartfona.

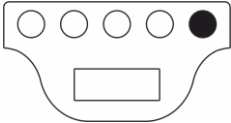
Siła sygnału Wi-Fi

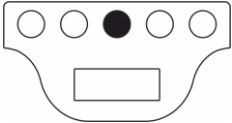

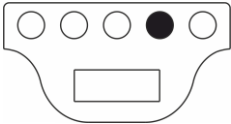
Jeśli grzejnik został zainstalowany w miejscu, w którym sygnał Twojej sieci Wi-Fi jest słaby, może wystąpić pewne spowolnienie w wykonywaniu poleceń wysyłanych za pośrednictwem aplikacji lub nawet chwilowe zakłócenie komunikacji. Aby rozwiązać problem, konieczne jest zwiększenie intensywności sygnału w obszarze instalacji.

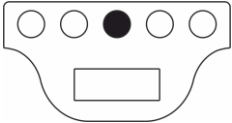
Zarządzanie modułem Wi-Fi:

Moduł Wi-Fi można włączać, wyłączać lub uruchomić w trybie punktu dostępowego zgodnie z potrzebami.

<p>Aby wyłączyć moduł Wi-Fi, naciśnij klawisz „F”, aż na wyświetlaczu pojawi się słowo WiFi.</p> 		<p>Naciśnij przycisk „-”, aby wyłączyć moduł.</p>  <p>Symbol  zniknie potwierdzając poprawne wykonanie czynności.</p>
<p>Aby włączyć moduł Wi-Fi, naciśnij klawisz „F”, aż na wyświetlaczu pojawi się słowo WiFi.</p> 		<p>Naciśnij klawisz „+”, aby włączyć moduł.</p>  <p>Symbol  pojawi się potwierdzając poprawne wykonanie czynności.</p>
<p>Aby ustawić moduł Wi-Fi w tryb punktu dostępu i przygotować go do połączenia z siecią Wi-Fi, naciśnij klawisz „F”, aż na wyświetlaczu pojawi się słowo WiFi.</p> 		<p>Naciśnij i przytrzymaj przycisk „+” przez 3 sekundy, aby zresetować moduł.</p>  <p>Wyświetlenie słowa „AP” potwierdza przywrócenie trybu punktu dostępu.</p>

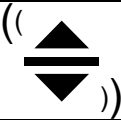
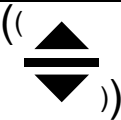



Status modułu Wi-Fi jest pokazywany na wyświetlaczu małą ikoną po prawej stronie.

<p>Wi-Fi WŁĄCZONE I PODŁĄCZONE DO INTERNETU</p>	<p>symbol wyświetla się ciągle</p>	
<p>Wi-Fi WŁĄCZONE, ale NIE PODŁĄCZONE DO SIECI lub PODŁĄCZONE DO SIECI BEZ INTERNETU</p>	<p>symbol miga</p>	
<p>Wi-Fi WŁĄCZONE i gotowe do początkowej konfiguracji</p>	<p>symbol miga</p>	
<p>Wi-Fi WYŁĄCZONE</p>	<p>symbol nie widoczny</p>	

Uwaga: po włączeniu produktu połączenie z siecią Wi-Fi i aplikacją wymaga co najmniej 30-sekundowego oczekiwania. Jeśli operacja się nie powiedzie, symbol Wi-Fi miga, a aplikacja pokazuje produkt jako odłączony. W takim przypadku konieczne jest wyłączenie grzejnika na co najmniej 30 sekund przed ponowną próbą.

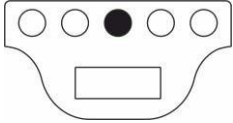
W paragrafie 7 znajdziesz informacje na temat rozwiązywania najczęstszych problemów i wyjaśnienia kodów błędów.

6.4 Narzędzia

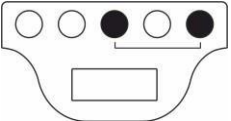
<p>Zablokowanie klawiatury</p> <p>Można zablokować przyciski sterowania grzejnikiem aby zapobiec przypadkowej lub niepożądaney zmianie. Aby przejść do funkcji blokady, przytrzymaj przycisk „F”</p> 		<p>Gdy zostanie wyświetlony napis „LOC”</p> <p>Przytrzymaj przycisk „F” i naciśnij „+” aby zablokować klawiaturę.</p>  <p>Uruchomienie jest wskazywane przez odpowiednią ikonkę która się zaświeci na wyświetlaczu . Przytrzymaj przycisk „F” i naciśnij „-” aby odblokować klawiaturę.</p> 
<p>Gdy ta funkcja jest aktywowana, a zasilanie elektryczne powróci po czasie dłuższym niż 30 minut, tryb działania ustawiony w momencie zaniku napięcia będzie wznowiony. Jeżeli tryb działania to jeden z trzech programów P1 zostanie aktywowany tryb Anti-freeze, ponieważ wymagane jest ustawienie godziny i dnia tygodnia przed ponownym aktywowaniem programu.</p>		

7. W razie problemów

Problem	Rozwiązanie
Grzejnik nie włącza się.	Sprawdź czy zasilanie zostało podłączone i czy odpowiada nalepce na grzejniku (np. 230 VAC 50 Hz) i czy główny wyłącznik który znajduje się z prawej strony jest włączony (pozycja „I”).
Grzejnik nie grzeje.	Upewnij się że tryb pracy jest jak pożądaney i czy ustawiony program nie jest w przedziale czasowym, w którym jest ustawiony tryb anti-freeze. Jeżeli temperatura otoczenie jest większa niż ustawiona grzejnik się nie uruchomi. W razie wątpliwości ustaw tryb komfortowy i zwiększ temperaturę dużo wyższą niż temperatura otoczenia, aby sprawdzić czy grzejnik działa prawidłowo.
Grzejnik pozostaje gorący.	Sprawdź temperaturę czy nie została ustawiona zbyt wysoka lub czy nie ma żadnych prądów powietrznych przy grzejniku, lub ustawić korektę mierzonej temperatury otoczenia.
Grzejnik nie dogrzewa pomieszczenia.	Sprawdź czy nie została ustawiona za niska temperatura i czy grzejnik ogrzewa tylko pomieszczenie w którym jest zainstalowane (pozostaw zamknięte drzwi) i czy główne zasilanie jest odpowiednie.
Grzejnik grzeje w trybie Eco.	Grzejnik może dogrzewać aby osiągnąć/utrzymać temperaturę Eco. Nie jest to niezwykle zachowanie.
Przednia powierzchnia grzejnika jest bardzo gorąca	Jest to normalne że przednia powierzchnia jest gorąca podczas pracy. Maksymalna wartość mieści się w ograniczeniach ustanowionych w normach bezpieczeństwa. Jeżeli grzejnik jest zawsze bardzo gorący, może być za mały dla pomieszczenia które ogrzewa lub może być narażone na prądy powietrzne.

Temperatura w pomieszczeniu różni się od temperatury ustawionej na grzejniku.	Po odczekaniu co najmniej 4 godzin, aby temperatura się ustabilizowała w pomieszczeniu, można zrobić korektę pomiędzy temperaturą otoczenia a wskazywaną przez grzejnik. Aby to zrobić zobacz rozdział 6.3 Korekta temperatury otoczenia.
Grzejnik wydziela nie przyjemny zapach.	Jeżeli grzejnik jest nowy istnieje możliwość, że jak zacznie pracować pierwszy raz, może być wyczuwalny nie przyjemny zapach. Jest to pozostałość po procesie składania grzejnika. Grzejniki które już były używane mogą wydzielać nie przyjemny zapach jeżeli nie były używane przez dłuższy czas i/lub są używane w pomieszczeniach zanieczyszczonych o słabej jakości powietrza.
Nie można wyświetlić sieci Wi-Fi generowanej przez produkt.	Ustaw się ze smartfonem w odległości nie większej niż 3 m od produktu. Sieć Wi-Fi generowana przez produkt jest wyświetlana w ustawieniach Wi-Fi smartfona, a nie w aplikacji.
Nie można połączyć się z siecią Wi-Fi wygenerowaną przez produkt, aby rozpocząć proces konfiguracji aplikacji.	Jeśli masz więcej niż jeden produkt, zaleca się włączenie i skonfigurowanie tylko jednego produktu naraz, aby nie pomylić sieci Wi-Fi generowanych przez różne produkty. Upewnij się, że poprawnie wpisałeś hasło sieciowe Password123
Urządzenie mobilne łączy się z siecią Wi-Fi utworzoną przez produkt, ale aplikacja wyświetla komunikat wskazujący, że nie znaleziono żadnego produktu.	Nie odsuwaj się od produktu podczas łączenia i wyłącz każdą inną sieć Wi-Fi, z którą smartfon może się automatycznie połączyć (z wyjątkiem tej, do której chcesz połączyć produkt). Sprawdź na wyświetlaczu produktu, czy moduł Wi-Fi jest aktywny, sprawdzając, czy symbol  wyświetla się i miga. Jeśli nie, postępuj zgodnie z instrukcjami, aby przywrócić produkt do trybu punktu dostępowego i spróbuj ponownie. Jeśli Wi-Fi produktu jest poprawnie aktywne, zamknij aplikację, otwórz ją ponownie, a następnie dodaj nowy produkt jako pierwszą operację.
Aplikacja nie wyświetla żadnej sieci Wi-Fi, z którą można połączyć urządzenie.	Upewnij się, że sieć Wi-Fi, z którą chcesz połączyć produkt, jest włączona i że sygnał dociera do obszaru, w którym produkt jest zainstalowany. Sprawdź intensywność sygnału w obszarze, w którym produkt jest zainstalowany. Sygnały, które są zbyt słabe lub mają różną intensywność, mogą powodować problemy z komunikacją. W takim przypadku musisz przenieść produkt do nowej lokalizacji lub poprawić sygnał sieci Wi-Fi, z którą chcesz się połączyć.
Po wybraniu sieci Wi-Fi, z którą chcesz połączyć urządzenie, pojawi się komunikat „Produkt nie może się połączyć z siecią”	Sprawdź, czy podałeś prawidłowe hasło sieciowe. Sprawdź, czy sieć Wi-Fi, z którą chcesz połączyć urządzenie, ma aktywne połączenie internetowe. Naciskaj przycisk Ponów próbę, aż procedura zakończy się powodzeniem. Jeśli po kilku próbach procedura się nie powiedzie, przywróć produkt do trybu punktu dostępu i wyłącz go na 1 minutę. Następnie powtórz procedurę od początku.

Jeśli wystąpi jakikolwiek problem z modulem Wi-Fi, na wyświetlaczu produktu pojawi się kod błędu, który pomoże ci rozwiązać problem:

Błąd	Opis	Rozwiązanie problemu
E01	Produkt nie może połączyć się z siecią Wi-Fi. Hasło wprowadzone w celu połączenia z pożądaną siecią Wi-Fi (inną niż wygenerowana przez produkt) jest nieprawidłowe lub sieć nie jest już dostępna lub zmieniła swoją nazwę.	Powtórz procedurę rejestracji, łącząc się z siecią Wi-Fi generowaną przez produkt i poczekaj, aż aplikacja ponownie wyświetli sieci, z którymi możesz się połączyć. Wybierz pożądaną i wprowadź ponownie prawidłowe hasło.
E02	Brak połączenia z internetem.	Przywróć połączenie internetowe.
E03	Serwer Radialight nieosiągalny.	<p>Konserwacja serwera może być w toku. Zwykle nie trwa dłużej niż kilka godzin. Poczekaj i sprawdź, czy błąd nie jest już wyświetlany, a ikona Wi-Fi przestała migać.</p> <p>Gdy problem będzie się powtarzał, usuń grzejnik z aplikacji, przywróć Wi-Fi produktu do trybu punkt dostępowy i powtórz całą procedurę rejestracji, tak jak gdyby produkt był nowy.</p> <p>Jeśli błąd pojawi się po pomyślnym zakończeniu rejestracji, oznacza to, że sygnał Wi-Fi odebrany przez grzejnik jest zbyt słaby lub zmienny i nie można zresetować połączenia. W takim przypadku przenieś grzejnik w inne miejsce lub wzmocnij sygnał Wi-Fi.</p>
E04	Rejestracja produktu na serwerze Radialight nie powiodła się.	Produkt jest automatycznie resetowany do trybu punkt dostępowy, aby móc powtórzyć całą procedurę rejestracji od samego początku.
E05	Moduł Wi-Fi wyłączony	Wyłącz produkt głównym wyłącznikiem na 1 minutę, a następnie włącz go ponownie.
E06	Błąd modułu Wi-Fi.	Gdy problem nie ustąpi, spróbuj go wyłączyć na co najmniej 1 godzinę, aby wyczyścić wewnętrzną pamięć tymczasową, a następnie włącz go ponownie.

8. Konserwacja

- Ten produkt nie wymaga specjalnej konserwacji.
- Czyszczenia produktu, zwłaszcza panela przedniego, suchą szmatką raz na 6 miesięcy.
- Jeśli produkt wymaga naprawy, należy skontaktować się z autoryzowanym serwisem technicznym.
- W przypadku wymiany kabla zasilającego, użyj 2x1.00mm² lub 3x1.00mm² typu H05RR-F HAR, w zależności od wersji. Ta operacja, dla przewodów wyposażonych w wtyczkę, lub bez niej, muszą być wykonywane przez wykwalifikowany personel, a nie przez użytkownika końcowego, w celu uniknięcia uszkodzenia urządzenia oraz zagrożenia bezpieczeństwa osobistego.

9. Informacja prawna



Środowisko i recykling

Pomóż nam chronić środowisko naturalne przez utylizację opakowania zgodnie z obowiązującymi przepisami państwowymi co do zarządzania odpadami.

Recykling starych urządzeń

Urządzenia z tym znakiem nie mogą być wyrzucane jako odpady komunalne. Muszą być zbierane osobno i utylizowane zgodnie z normami lokalnymi.

PL - Informacje wymagane dla lokalnych elektrycznych ogrzewaczy pomieszczeń

Model: KLIMA Wi-Fi					
Opis	Symbol	Wartość	Jednostka	Opis	Jednostka
Moc grzewcza				Rodzaj wejścia ciepła, dla elektrycznych miejscowych ogrzewaczy pomieszczeń (wybierz jeden)	
Nominalna moc grzewcza	P_{nom}	(*) Patrz Tabela 1	kW	Ręczna regulacja ładowania ciepła, z wbudowanym termostatem	nie
Minimalna moc grzewcza(orientacyjny)	P_{min}	(*) Patrz Tabela 1	kW	Ręczna regulacja ładowania ciepła z odczytem temperatury pokojowej i/lub temperatury zewnętrznej	nie
Maksymalna ciągła moc grzewcza	$P_{max,c}$	(*) Patrz Tabela 1	kW	Elektroniczna regulacja ładowania ciepła z odczytem temperatury pokojowej i/lub temperatury zewnętrznej	nie
Dodatkowe zużycie energii elektrycznej				Ciepło wspomagane wentylatorem	nie
Przy nominalnej mocy grzewczej	e_{lmax}	0,000	kW	Rodzaj mocy grzewczej/kontroli temperatury pokojowej (wybierz jedną)	
Przy minimalnej mocy grzewczej	e_{lmin}	0,000	kW	Jednostopniowe wytwarzanie ciepła i brak kontroli temperatury w pomieszczeniu	nie
W trybie czuwania (standby)	e_{lSB}	0,00049	kW	Dwa lub więcej ręcznych etapów, brak kontroli temperatury w pomieszczeniu	nie
				Z ręczną regulacją temperatury pomieszczenia	nie
				Z elektroniczną regulacją temperatury pomieszczenia	nie
				Elektroniczna regulacja temperatury w pomieszczeniu plus zegar dzienny	nie
				Elektroniczna regulacja temperatury w pomieszczeniu plus zegar tygodniowy	tak
				Inne opcje sterowania (możliwe wielokrotne wybory)	
				Kontrola temperatury w pomieszczeniu, z wykrywaniem obecności	tak
				Kontrola temperatury w pomieszczeniu, z wykrywaniem otwartego okna	tak
				Z opcją kontroli odległości	nie
				Z adaptacyjną kontrolą startu	nie
				Z ograniczeniem czasu pracy	nie
				Z czujnikiem black bulb	nie
Dane producenta:		Ermete Giudici S.p.A. - via L. da Vinci 27 - 20090 Segrate (MI) Italia			

Tabela 1		KLIMA 7 KLIMA 7 AS	KLIMA 10	KLIMA 15	KLIMA 20
Moc grzewcza					
Nominalna moc grzewcza	P_{nom}	0,750	1,000	1,500	2,000
Minimalna moc grzewcza(orientacyjnie)	P_{min}	0,075	0,113	0,150	0,188
Maksymalna ciągła moc grzewcza	$P_{max,c}$	0,750	1,000	1,500	2,000

